

DK Styretavle for Svømmetrænepumper / SPA
 EN Control panel for jet-stream pumps / SPA / Whirlpool
 DE Bedienfeld für Strahlpumpen / SPA / Whirlpool

Elektriske tilslutninger / Electrical connections / Elektrische Anschlüsse

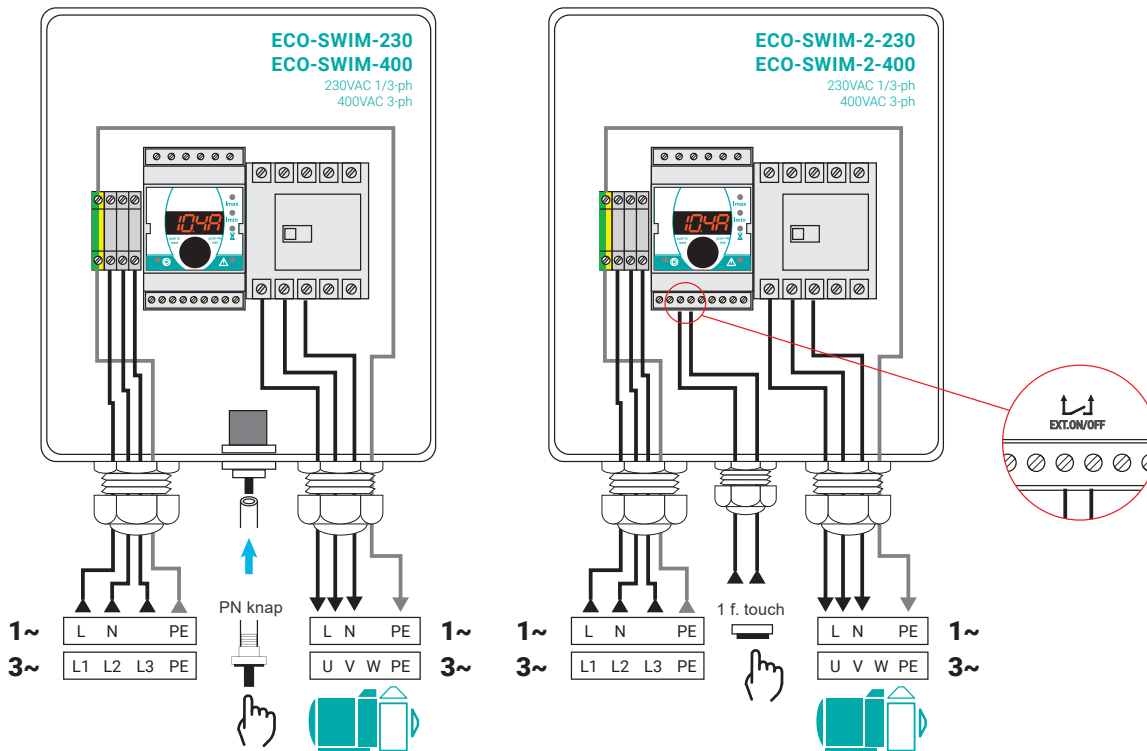

Styreenhed / Control module / Steuerungmodul

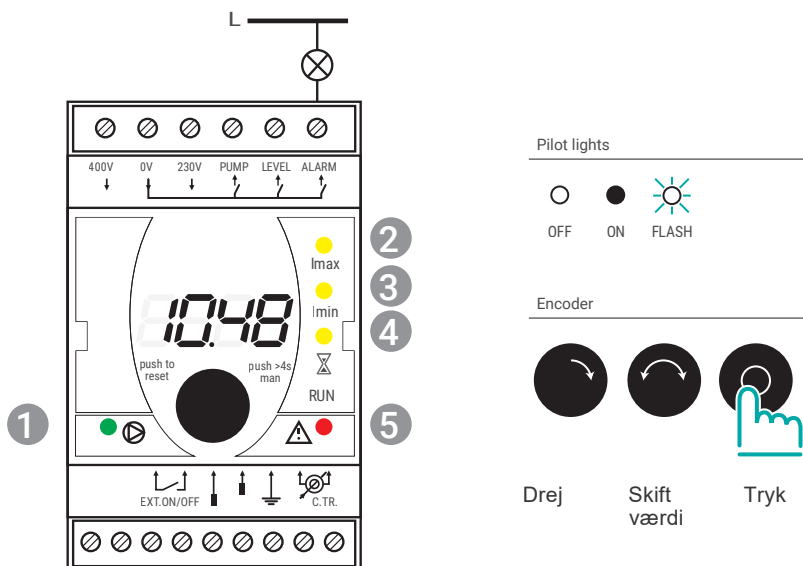

Kontrollsyndioder:

1. Pumpe drift
2. Indstilling Max amp.forbrug
3. Indstilling Min. amp.forbrug
4. Indstilling Timer
5. Alarm

Pilot lights:

1. Pump running.
2. Overload setting.
3. Underload setting.
4. Timer setting.
5. Alarm.

Kontrollleuchten:

1. Pumpe läuft.
2. Einstellung Überlast.
3. Einstellung Unterlast.
4. Timer-Einstellung.
5. Alarm.

Funktion / Operation / Betrieb

Tænd/sluk pumpe på styreenhed
Local pump start/stop (module)
Lokaler Start/Stop der Pumpe

Tænd/sluk pumpe eksternt
Remote pump start/stop
Fernstart/Stop der Pumpe

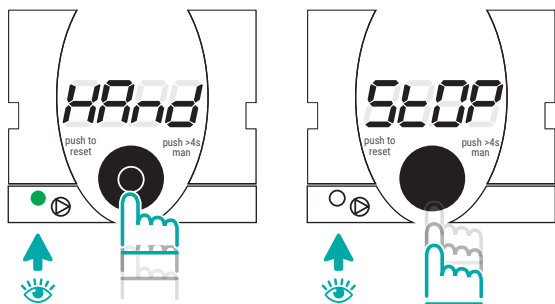

Tryk >4sek
Manual ON

Manual OFF

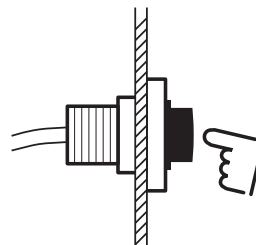

PN knap / 1 funktions touch

Pumpe motorværn / Pump thermal protection / Wärmeschutz der Pumpe

! DK: Ved første opstart vil styreenheden udføre en auto. indstilling af amp.forbruget (Auto-tune).
EN: At the first start-up, the controller will perform an auto-calibration of thermal protection (Auto-tune).
DE: Bei der ersten Inbetriebnahme stellt das Gerät automatisch den Wärmeschutz ein. (Auto-tune).

Gentagelse af funktionen **Auto-tune**
How to repeat **Auto-tune**
Wiederholung der Funktion **Auto-tune**

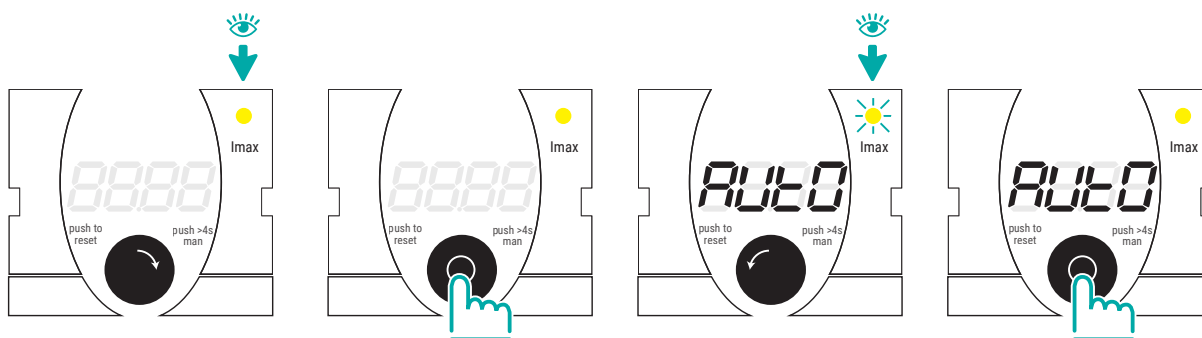

Vælg
parameter

Aktuel
værdi

Drej mod
Venstre

Godkend

Ændring af værdierne (I_{max}, I_{min}, Time)
 How to change the parameters (I_{max}, I_{min}, Timer)
 Änderung der Parameter (I_{max}, I_{min}, Rückstellzeit)

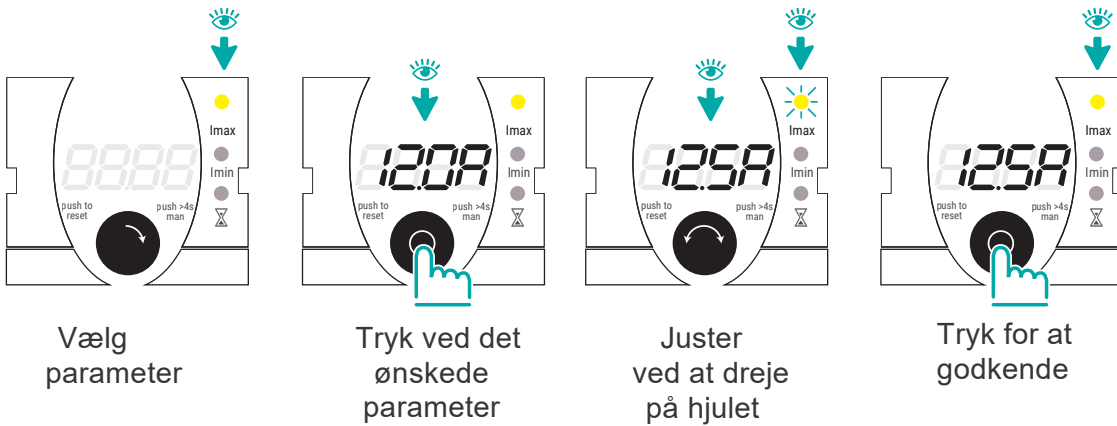

Nulstil Alarmer
 Alarms reset
 Alarm zurücksetzen

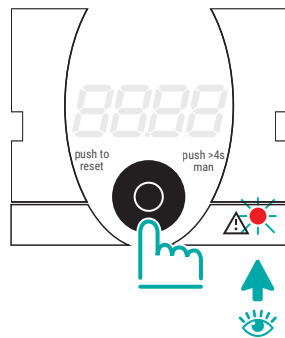

System status

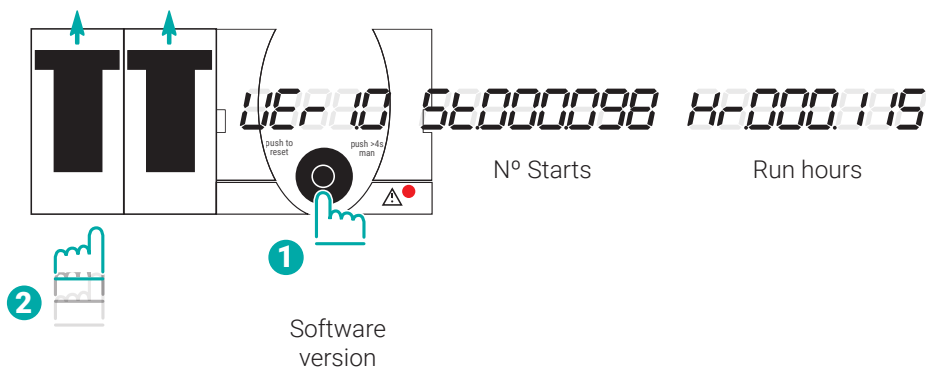

Fejl meddelelser / Alarm messages / Fehlermeldungen



For høj amp. forbrug / Overload / Überlast



For lavt amp. forbrug / Underload / Unterlast

Indgangsspænding	230Vac 1/3-fase eller 400Vac 3-fase (afhængig af model) - 50/60Hz
Beskyttelse	Min./Max. amp. forbrug, fase mangel, ved overdreven start/stop frekvens
Display	4 digitale LED
Pneumatisk knap	Tilslutning med pn slange indv. Ø 2,5mm (afhængig af model)
1 funktions touch	5Vdc, N.O. (puls)
Pumpe udgang (PUMP)	16A max
Alarm udgang (ALARM)	230 o 400Vac, 5A max
Max. amp.forbrug indstilling	Auto - 0.6...40A (frakobler ved 7s)
Min. amp.forbrug indstilling	OFF - 0.5...40A (frakobler efter 4 s ved 20 s starts forsinkelse)
Tids indstilling	OFF - 1'...240'
Max kabel terminal mm2	4mm ² (Main tilslutninger) / 2,5mm ² (Styreenhed)
IP / Temperatur	IP65 / -10°...+55°C
Dimensioner (AxBxC)	170x230x120mm
Version software	V.1.1

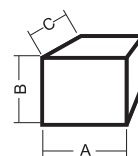

Power supply	230Vac 1/3-ph or 400Vac 3-ph (depending on model) - 50/60Hz
Protections	Overload, Underload, Phase loss, Excessive starting frequency
Display	4-digit LED
Air switch	For connecting tube with internal Ø 2,5mm
Piezo switch	5Vdc, N.O. (pulse)
Pump output (PUMP)	16A maximum
Main alarm output (ALARM)	230 or 400Vac, 5A maximum
Maximum current setting	Auto - 0.6...40A (trip in 7 s)
Minimum current setting	OFF - 0.5...40A (trip in 4 s with 20 s starting delay)
Timer setting	OFF - 1'...240'
Maximum terminal cross-section	4mm ² (power) / 2,5mm ² (control)
IP / Temperature	IP65 / -10°...+55°C
Dimensions (AxBxC)	170x230x120mm
Software	V.1.1

Versorgungsspannung	230Vac 1/3-ph oder 400Vac 3-ph (je nach Model) - 50/60Hz
Schutz	Überlast, Unterlast, Phasenausfall, Hochfrequenz Starts-Erkennung
Display	4 digit LED Anzeige
Luftschalter	Für Verbindungsschläuche mit Innen-Ø 2,5mm
Piezo-Schalter	5Vdc, N.O. (impuls)
Pumpenausgang (PUMP)	16A maximum
Alarm Level Ausgang (ALARM)	230 oder 400Vac, 5A maximum
Maximale Stromeinstellung	Auto - 0.6...40A (Auslösung in 7 s)
Minimale Stromeinstellung	OFF - 0.5...40A (Auslösung in 4 s mit 20 s Start Verzögerung)
Timer-Einstellung	OFF - 1'...240'
Max. Kabelquerschnitt	4mm ² (Spannung) / 2,5mm ² (Steuerung)
IP / Temperatur	IP65 / -10°...+55°C
Abmessung (AxBxC)	170x230x120mm
Software	V.1.1

