



# **INSTALLATION AND USER MANUAL**

**DK-SE-DE-EN**

Thank you for choosing Inverter heat pump.

This manual provides you necessary information for optimal use and maintenance, please read it carefully and keep it for subsequent use.

# Summary

## ***For users ..... P.1-P.7***

1. General information: .....	- 3 -
1.1. Contents: .....	- 3 -
1.2. Operating conditions and range: .....	- 3 -
1.3. Advantages of different modes: .....	- 3 -
1.4. Kind reminder: .....	- 4 -
2. Operations .....	- 6 -
2.1. Notice before using .....	- 6 -
2.2. Operation instructions .....	- 6 -
2.3. Daily maintenance and winterizing .....	- 8 -
3. Technical specification .....	- 9 -

## ***For installers and professionals ..... P.10-P.22***

1. Transportation .....	- 10 -
2. Installation and maintenance .....	- 10 -
2.1. Notice before installation: .....	- 10 -
2.2. Installation instruction .....	- 11 -
2.3. Trial after installation .....	- 14 -
2.4. Maintenance and winterizing .....	- 14 -
3. Trouble shooting for common faults .....	- 15 -
4. Failure code .....	- 16 -
5. Wifi setting .....	- 19 -



## Warning:

- g. Please read the following tips before installation, use and maintenance.
- h. Installation, removal and maintenance must be carried out by Professional personial in accordance with the instructions.
- i. Gas leakage test must be done before and after installation.

### 1. Use

- e. It must be installed or removed by professionals, and it is forbidden to dismantle and refit without permission.
- f. **Don't put obstacles before the air inlet and outlet of the heat pump.**

### 2. Installation

- i. This product must be kept away from any source of fire.

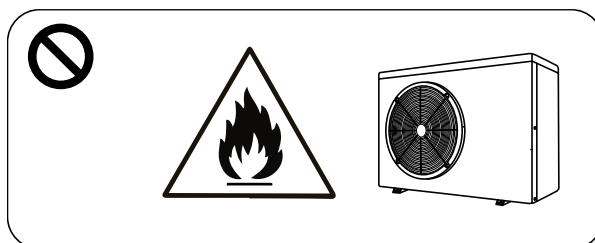

- j. The installation can't be in a closed environment or indoors, and must be kept well ventilated.

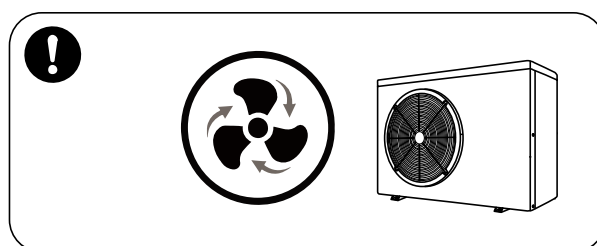

- k. Vacuum completely before welding, field welding is not allowed, welding can only be performed by professional personnel in professional maintenance center.

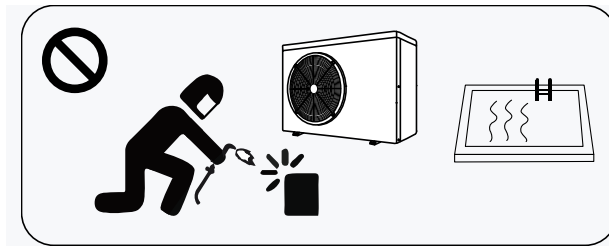

- i. Installation must be stopped if any gas leakage, and the unit must be returned to professional maintenance center.

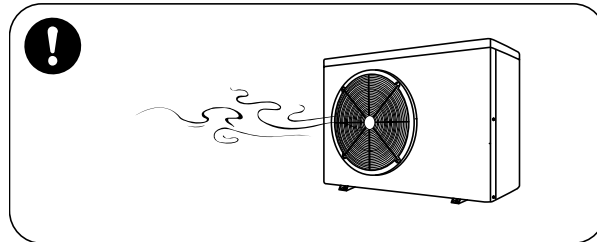

### 3. Transportation & Storage

- i. Sealing is not allowed during transportation
- j. Transporting goods at a constant speed is needed to avoid sudden acceleration or sudden braking, so as to reduce the collision of goods.
- k. The unit must be far away from any source of fire.
- l. Storage place must be bright, wide, open and good ventilation, ventilation equipment is required.

### 4. Maintenance Notice

- g. If maintenance or scrap is required, contact an authorized service center nearby
- h. Qualification requirement  
All operators who dispose gas must be qualified by valid certification which issued by professional agency.
- i. Please strictly comply with the requirement from manufacturer when maintenance or filling gas. please refer to the technical service manual.

## > 1. General information:

### 1.1. Contents:

After unpacking, please check if you have all the following components.

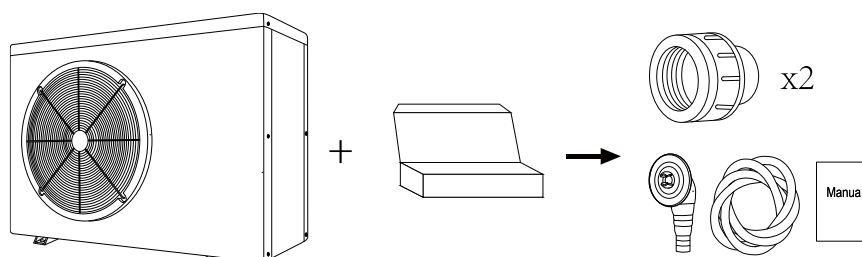

### 1.2. Operating conditions and range:

ITEMS		RANGE
<b>Operating range</b>	Air temp	-7°C~43°C
<b>Temp. setting</b>	heating	18°C~40°C

*The heat pump will have ideal performance in the operation range Air 15°C~25°C*

### 1.3. Advantages of different modes:

The heat pump has two modes: Smart and Silence. They have different advantages under different conditions

MODE	RECOMMENDATION	ADVANTAGES
	Smart mode As standard	Heating capacity: 20% to 100% capacity Intelligent optimization Fast heating
	Silence mode Use at night	Heating capacity: 20% to 80% capacity Sound level: 3dB (A) lower than Smart mode.

## 1.4. Kind reminder:

 This heat pump has Power-off memory function. When the power is recovered, the heat pump will restart automatically.

1.4.1. The heat pump can only be used to heat the pool water. It can NEVER be used to heat other flammable or turbid liquid.

1.4.2. Don't lift the water union when moving the heat pump since the titanium heat exchanger inside the heat pump will be damaged.

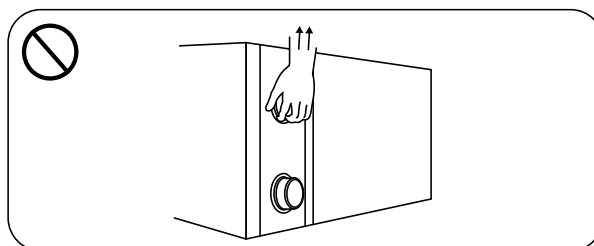

1.4.3. Don't put obstacles before the air inlet and outlet of the heat pump.

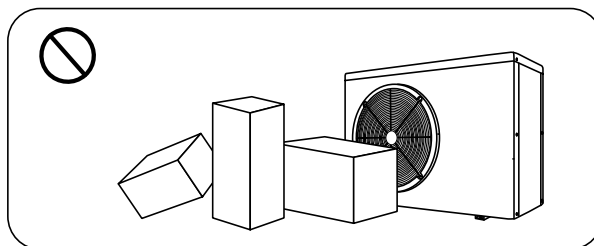

1.4.4. Don't put anything into inlet or outlet, or the efficiency of the heat pump will be reduced or even stopped.

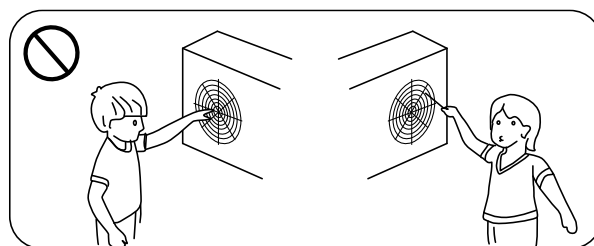

1.4.5. Don't use or store combustible gas or liquid such as thinners, paint and fuel to avoid fire.

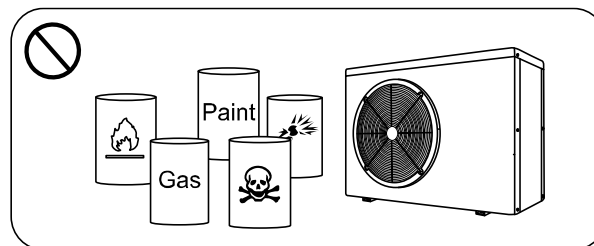

1.4.6. If any abnormal circumstances occurred, e.g.: abnormal noises, smells, smokes and leakage of electricity, switch off the main power immediately and contact your local dealer. Don't try to repair the heat pump by yourselves.

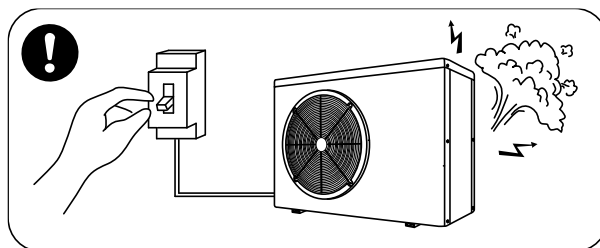

1.4.7. The main power switch should be out of the reach of Children.

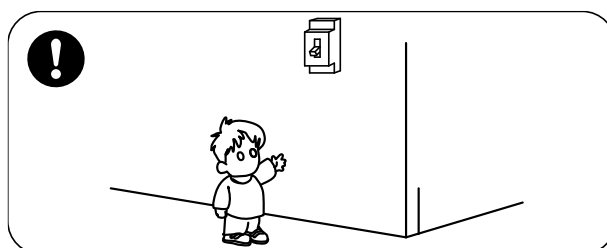

1.4.8. Please cut off the power in the lightning storm weather.

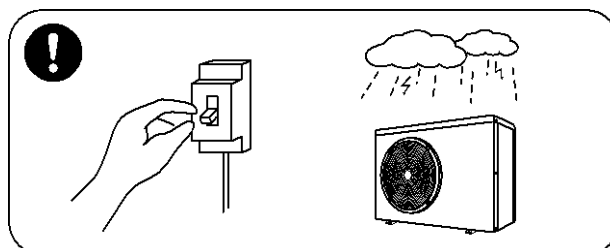

1.4.9. Please note that following codes are not failure.

	CODES
No water flow	E3
Anti-Freezing Reminder	Ed
Out of the operating range	Eb
Insufficient water flow or pump blocked	E6
Power abnormal	E5





## > 2. Operations

### 2.1. Notice before using

- ① For longer service life, please ensure water pump on before heat pump on, and water pump off after heat pump off.
- ② Ensure no water leakage on piping system, then unlock screen and press  to power on heat pump.

### 2.2. Operation instructions



SYMBOL	DESIGNATION	FUNCTION
	ON/OFF	1.Power On/Off 2.Wifi setting
	Unlock	Press it for 3 seconds to unlock/lock screen
	Speed	Select Smart/Silence mode
	Up / Down	Adjust set temperature

Note:



① Screen lock:





- a. If no operation in 30 seconds, screen will be locked.
- b. When HP is off, screen will be dark and "0%" will be displayed.

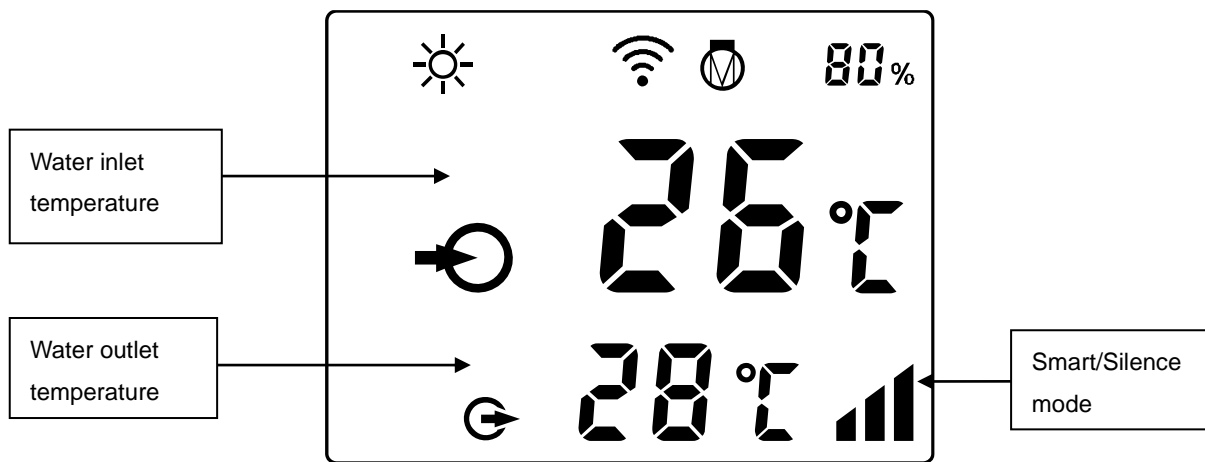

c. Press  for 3 seconds to lock screen and it will be dark



② Screen unlock:

- c. Press  for 3 seconds to unlock screen and it will be lit up.
- d. Only after screen is unlocked, any other buttons can be functioned.





	Heating
	Compressor
80%	Heating capacity percentage
	Wifi connection
	Water inlet
	Water outlet

1.Power On: Press  for 3 seconds to light up screen, then press  to power on heat pump.

2.Adjust Set Temperature: When screen is unlocked, press  or  to display or adjust the set temperature.



### 3.Smart/Silence mode selection:





① Smart mode as default will be activated when heat pump is on, and screen shows .

② Press  to enter Silence mode, and screen shows .

(Suggestion: select Smart mode for initial heating.)

### 4.Defrosting

a. Auto Defrosting: When heat pump is defrosting,  will be flashing. After defrosting,  will stop flashing.

b. Compulsory Defrosting: When heat pump is heating, press  and  together for 5 seconds to start compulsory defrosting, and  will be flashing. After defrosting,  will stop flashing.

(Note: Compulsory defrosting intervals should be more than 30 minutes and the compressor should run for more than 10 minutes.)

## 2.3. Daily maintenance and winterizing

### 2.3.1. Daily Maintenance

 Please don't forget to cut off power supply of the heat pump

- ① Please clean the evaporator with household detergents or clean water, NEVER use gasoline, thinners or any similar fuel.
- ② Check bolts, cables and connections regularly.

### 2.3.2. Winterizing

In winter season when you don't swim, please cut off power supply and drain water out of the heat pump. When using the heat pump under 2°C, make sure there is always water flow.

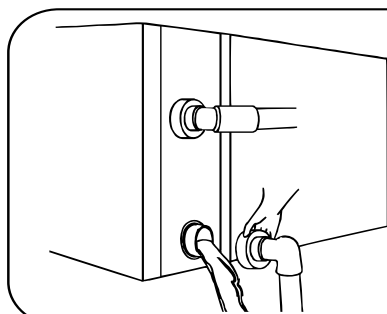

#### Important:

Unscrew the water union of inlet pipe to let the water flow out.

When the water in machine freezes in winter season, the titanium heat exchanger may be damaged.

### > 3. Technical specification

Model	34-180160	34-180161	34-180162	34-180163	34-180164	34-180165	34-180166
<b>Advised pool volume (m<sup>3</sup>)</b>	20~40	25~45	30~55	35~65	40~75	65~120	90~160
<b>Working air temp (°C)</b>	<b>-7~43</b>						
<b>Performance Condition: Air 26°C, Water 26°C, Humidity 80%</b>							
<b>Heating capacity (kW)</b>	8.4	10.3	12.8	15.0	17.3	27.0	35.6
<b>C.O.P</b>	14.1~7.0	14.5~6.9	15.0~7.4	15.5~6.7	14.8~5.9	14.5~6.2	14.6~5.5
<b>C.O.P at 50% speed</b>	10.3	10.4	11.0	10.9	10.5	10.8	10.3
<b>Performance Condition: Air 15°C, Water 26°C, Humidity 70%</b>							
<b>Heating capacity (kW)</b>	6.1	7.1	8.3	10.5	11.4	18.0	24.0
<b>C.O.P</b>	7.0~4.8	7.3~4.6	7.7~4.8	7.8~4.6	7.5~4.3	7.6~4.5	7.7~4.5
<b>C.O.P at 50% speed</b>	6.3	6.4	6.8	6.6	6.1	6.5	6.8
<b>Rated input power(kW) at air 15°C</b>	0.17~1.2	0.19~1.5	0.22~1.73	0.27~2.2	0.3~2.6	0.53~3.9	0.62~5.2
<b>Rated input current(A) at air 15°C</b>	0.74~5.2	0.83~6.5	0.96~7.52	1.17~9.6	1.3~11.3	0.76~5.6	0.89~7.4
<b>Power supply</b>	<b>230V/1 Ph/50Hz</b>					<b>400V/3 Ph/50Hz</b>	
<b>Advised water flux (m<sup>3</sup>/h)</b>	2~4	3~4	4~6	5~7	6.5~8.5	10~12	12~18
<b>Sound pressure 1m dB(A)</b>	38.8~48.2	38.6~49.9	42.1~50.7	41.3~54.0	43.1~53.8	43.5~54.9	42.6~54.7
<b>Sound pressure 10m dB(A)</b>	18.8~28.2	18.6~29.9	22.1~30.7	21.3~34.0	23.1~33.8	23.5~34.9	22.6~34.7
<b>Water pipe in-out Spec (mm)</b>	<b>50</b>						
<b>Net Dimension LxWxH (mm)</b>	961×340× 658	961×340× 658	961×340× 658	961×340× 658	961×420× 658	1092×420× 958	1161×530× 958
<b>Net Weight (kg)</b>	<b>45</b>	<b>49</b>	<b>50</b>	<b>52</b>	<b>63</b>	<b>93</b>	<b>120</b>

1. The values indicated are valid under ideal conditions: Pool covered with an isothermal cover, filtration system running at least 15 hours a day
2. Related parameters are subject to adjustment periodically for technical improvement without further notice. For details please refer to nameplate.

## > 1. Transportation

1.1. When storing or moving the heat pump, the heat pump should be at the upright position.

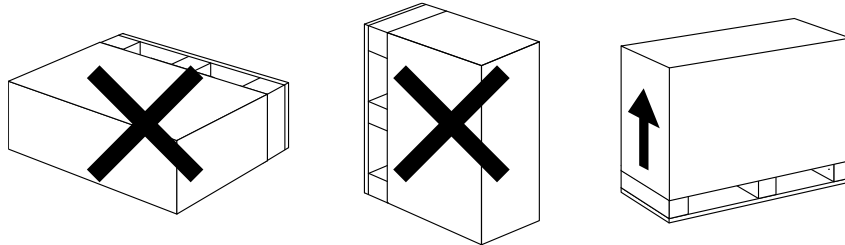

1.2. When moving the heat pump, do not lift the water union since the titanium heat exchanger inside the heat pump will be damaged.

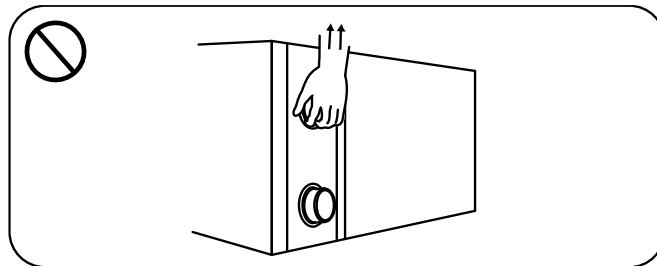

## > 2. Installation and maintenance

 The heat pump must be installed by a professional team. The users are not qualified to install by themselves, otherwise the heat pump might be damaged and risky for users' safety.

2.1. Notice before installation :

2.1.1. The inlet and outlet water unions can't bear the weight of soft pipes. The heat pump must be connected with hard pipes!

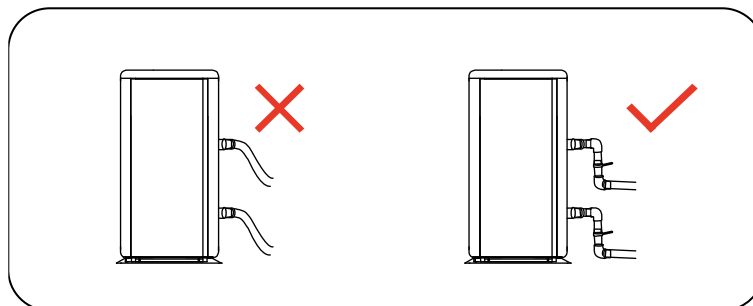

2.1.2. In order to guarantee the heating efficiency, the water pipe length should be  $\leq 10\text{m}$  between the pool and the heat pump

## 2.2. Installation instruction

### 2.2.1. Location and size

 The heat pump should be installed in a place with good ventilation

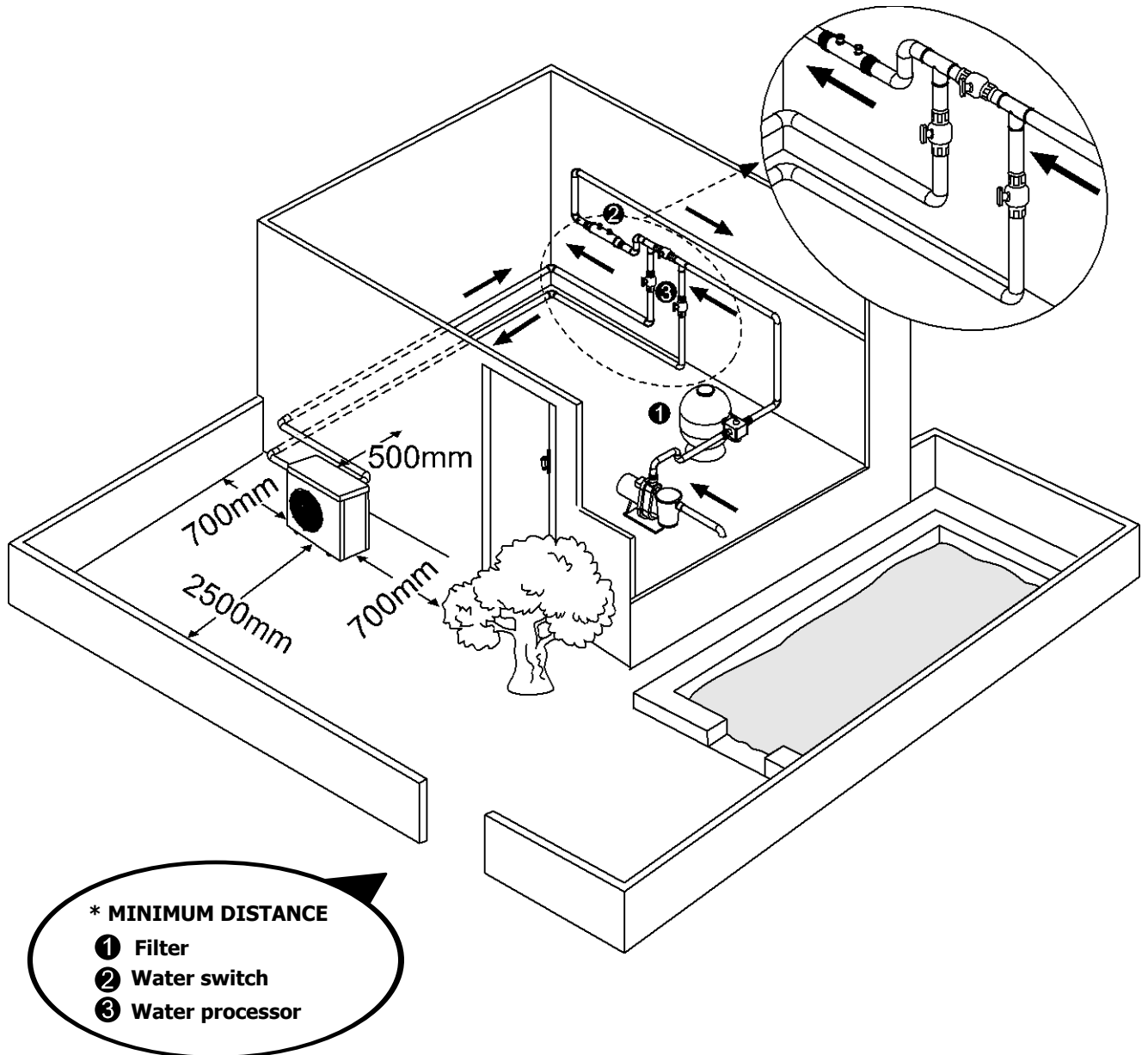

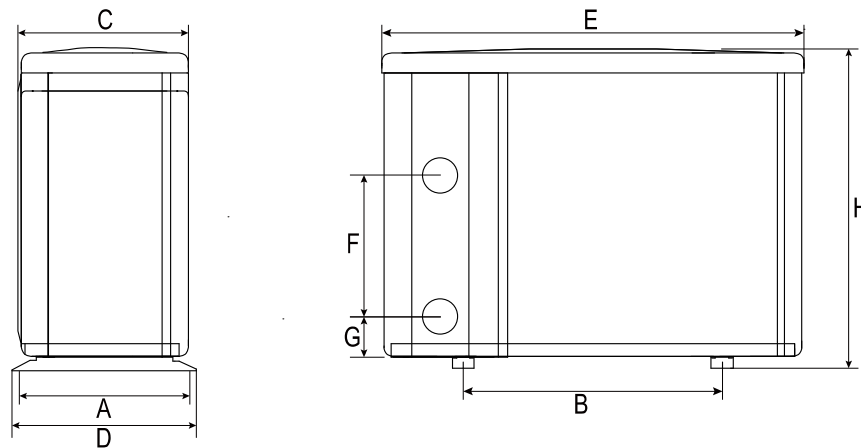

UNIT=MM		A	B	C	D	E	F	G	H
<b>MODEL</b>	<b>34-180160</b>	315	590	312	340	961	250	74	658
	<b>34-180161</b>	315	590	312	340	961	290	74	658
	<b>34-180162</b>	315	590	312	340	961	280	74	658
	<b>34-180163</b>	315	590	312	340	961	340	74	658
	<b>34-180164</b>	395	590	392	420	961	390	74	658
	<b>34-180165</b>	395	720	392	420	1092	620	74	958
	<b>34-180166</b>	505	790	496	530	1161	650	74	958

**※ Above data is subject to modification without notice.**

### 2.2.2. Heat pump installation.

- ① The frame must be fixed by bolts (M10) to concrete foundation or brackets. The concrete foundation must be solid; the bracket must be strong enough and anti-rust treated;
- ② The heat pump needs a water pump (Supplied by the user). The recommended pump specification-flux: refer to Technical Parameter, Max. lift  $\geq 10\text{m}$
- ③ When the heat pump is running, there will be condensation water discharged from the bottom, please pay attention to it. Please insert the drainage tube(accessory) into the hole and clip it well, then connect a pipe to drain off the condensation water.

### 2.2.3. Wiring & protecting devices and cable specification

- ① Connect to appropriate power supply, the voltage should comply with the rated voltage of the products.
- ② Well earth the heat pump.
- ③ Wiring must be connected by a professional technician according to the circuit diagram.
- ④ Set breaker or fuse according to the local code (leakage operating current  $\leq 30\text{mA}$ ).
- ⑤ The layout of power cable and signal cable should be orderly and not affecting each other.

**⚠** 1. Wiring diagram

**A. For power supply: 230V 50Hz**

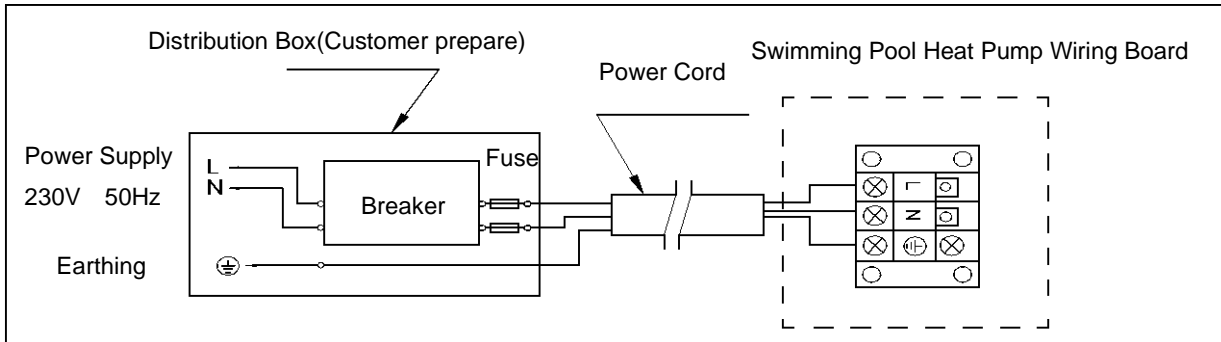

**B. For power supply: 400V 50Hz**

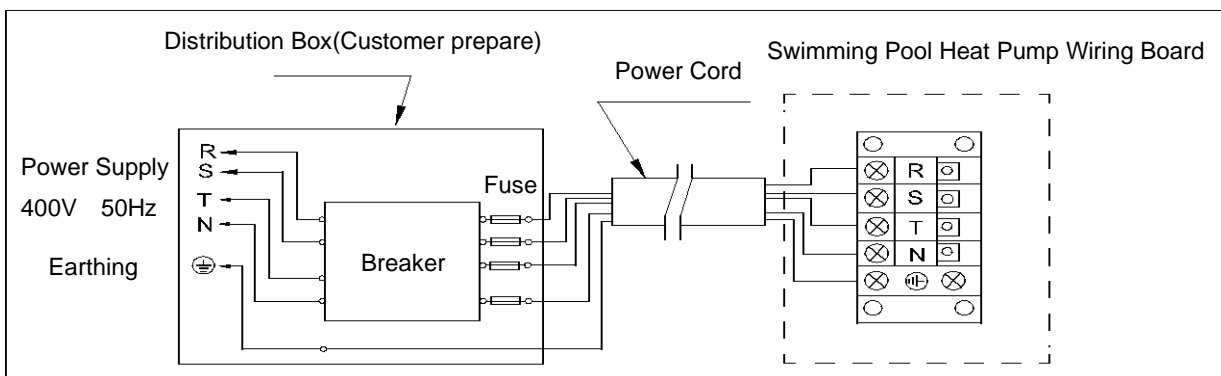

Note:

**⚠** Must be hard wired, no plug allowed.

- For your safe use in winter, it's strongly recommended to equip heating priority function.
- For the detailed wiring diagram, please refer to Appendix 1.

**i** 2. Options for protecting devices and cable specification

MODEL		34-180160	34-180161	34-180162	34-180163	34-180164	34-180165	34-180166
Breaker	Rated Current A	10.5	12.0	14.5	16.5	18.0	9.0	12.0
	Rated Residual Action Current mA	30	30	30	30	30	30	30
Fuse	A	10.5	12.0	14.5	16.5	18.0	9.0	12.0
Power Cord (mm <sup>2</sup> )		3×2.5	3×2.5	3×2.5	3×2.5	3×4	5×2.5	5×2.5
Signal cable (mm <sup>2</sup> )		3×0.5	3×0.5	3×0.5	3×0.5	3×0.5	3×0.5	3×0.5

*NOTE: The above data is adapted to power cord ≤ 10m .If power cord is >10m, wire diameter must be increased. The signal cable can be extended to 50m at most.*

## 2.3. Trial after installation

**⚠** Please check all the wirings carefully before turning on the heat pump.

### 2.3.1. Inspection before use

- ① Check installation of the whole heat pump and the pipe connections according to the pipe connecting drawing;
- ② Check the electric wiring according to the electrical wiring diagram and earthing connection;
- ③ Make sure that the main power is well connected;
- ④ Check if there is any obstacle in front of the air inlet and outlet of the heat pump

### 2.3.2. Trial

- ① The user is advised to start the water pump before the heat pump, and turn off the heat pump before the water pump for long life circle.
- ② The user should start the water pump, and check for any leakage of water; Power on and press the ON/OFF button of the heat pump, and set desired temperature in the thermostat.
- ③ In order to protect the heat pump, the heat pump is equipped with start delay function. When starting the heat pump, the fan will start to run in 3 minutes, in another 30 seconds, the compressor will start to run.
- ④ After pool heat pump starts up, check for any abnormal noise from the heat pump.
- ⑤ Check the temperature setting.

## 2.4. Maintenance and winterizing

### 2.4.1 Maintenance

**⚠** The maintenance should be carried out once per year by qualified professional technician.

- ① Cut off power supply of the heat pump before cleaning, examination and repairing . Do not touch the electronic components until the LED indication lights on PCB turn off.
- ② Please clean the evaporator with household detergents or clean water, NEVER use gasoline, thinners or any similar fuel.
- ③ Check bolts, cables and connections regularly.

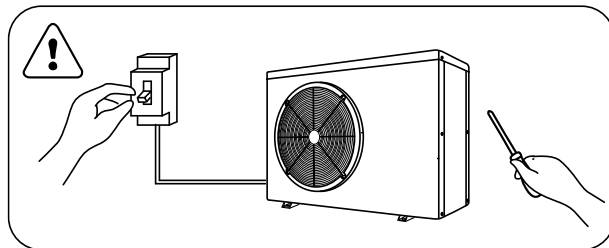



### 2.4.2 Winterizing

In winter season when you don't swim, please cut off power supply and drain water out of the heat pump. When using the heat pump under 2°C, make sure there is always water flow.

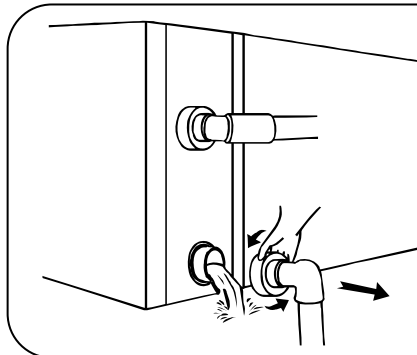

**! Important:**

Unscrew the water union of inlet pipe to let the water flow out. When the water in machine freezes in winter season, the titanium heat exchanger may be damaged.

## > 3. Trouble shooting for common faults

FAILURE	REASON	SOLUTION
<b>Heat pump doesn't run</b>	No power	Wait until the power recovers
	Power switch is off	Switch on the power
	Fuse burned	Check and change the fuse
	The breaker is off	Check and turn on the breaker
<b>Fan running but with insufficient heating</b>	evaporator blocked	Remove the obstacles
	Air outlet blocked	Remove the obstacles
	3 minutes start delay	Wait patiently
<b>Display normal, but no heating</b>	Set temp. too low	Set proper heating temp.
	3 minutes start delay	Wait patiently

If above solutions don't work, please contact your installer with detailed information and your model number. Don't try to repair it yourself.

**ATTENTION! Please don't try to repair the heat pump by yourself to avoid any risk.**

## > 4. Failure code

NO.	DISPLAY	NOT FAILURE DESCRIPTION
1	<b>E3</b>	No water protection
2	<b>E5</b>	Power supply excesses operation range
3	<b>E6</b>	Excessive temp difference between inlet and outlet water(Insufficient water flow protection)
4	<b>Eb</b>	Ambient temperature too high or too low protection
5	<b>Ed</b>	Anti-freezing reminder
NO.	DISPLAY	FAILURE DESCRIPTION
1	<b>E1</b>	High pressure protection
2	<b>E2</b>	Low pressure protection
3	<b>E4</b>	3 phase sequence protection (three phase only)
4	<b>E7</b>	Water outlet temp too high or too low protection
5	<b>E8</b>	High exhaust temp protection
6	<b>EA</b>	Evaporator overheat protection (only at cooling mode)
7	<b>P0</b>	Controller communication failure
8	<b>P1</b>	Water inlet temp sensor failure
9	<b>P2</b>	Water outlet temp sensor failure
10	<b>P3</b>	Gas exhaust temp sensor failure
11	<b>P4</b>	Evaporator coil pipe temp sensor failure
12	<b>P5</b>	Gas return temp sensor failure
13	<b>P6</b>	Cooling coil pipe temp sensor failure
14	<b>P7</b>	Ambient temp sensor failure
15	<b>P8</b>	Cooling plate sensor failure
16	<b>P9</b>	Current sensor failure
17	<b>PA</b>	Restart memory failure
18	<b>F1</b>	Compressor drive module failure
19	<b>F2</b>	PFC module failure
20	<b>F3</b>	Compressor start failure
21	<b>F4</b>	Compressor running failure
22	<b>F5</b>	Inverter board over current protection
23	<b>F6</b>	Inverter board overheat protection
24	<b>F7</b>	Current protection
25	<b>F8</b>	Cooling plate overheat protection
26	<b>F9</b>	Fan motor failure
27	<b>Fb</b>	Power filter plate No-power protection
28	<b>FA</b>	PFC module over current protection

Appendix 1: Heating priority wiring diagram (Optional)

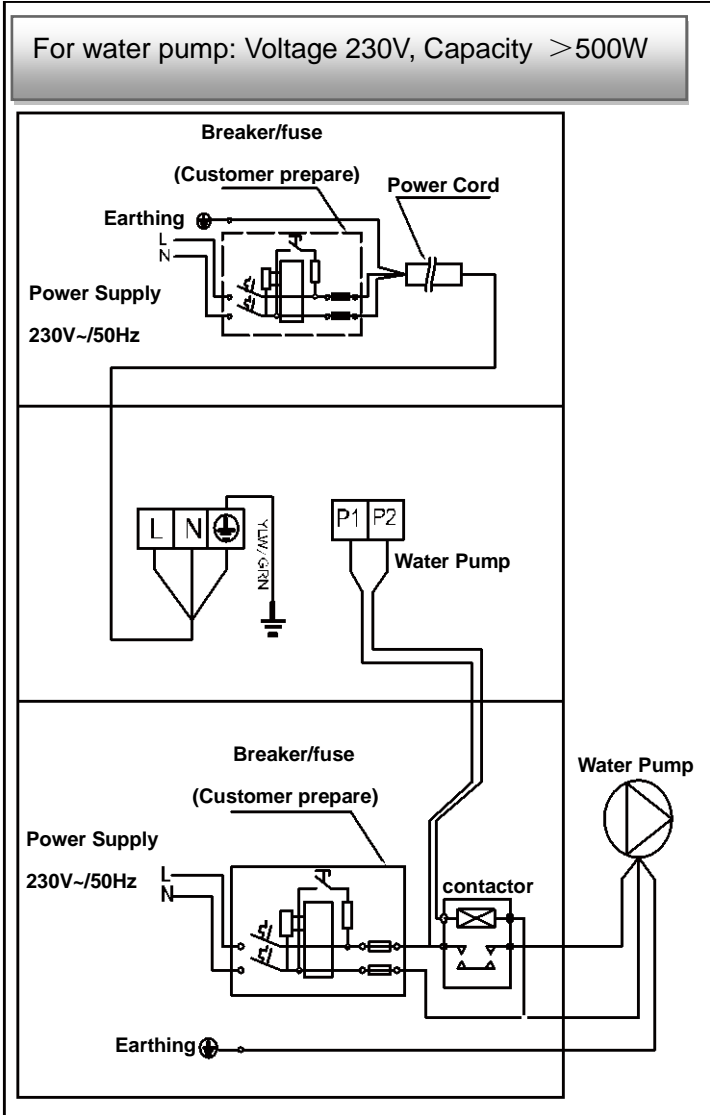
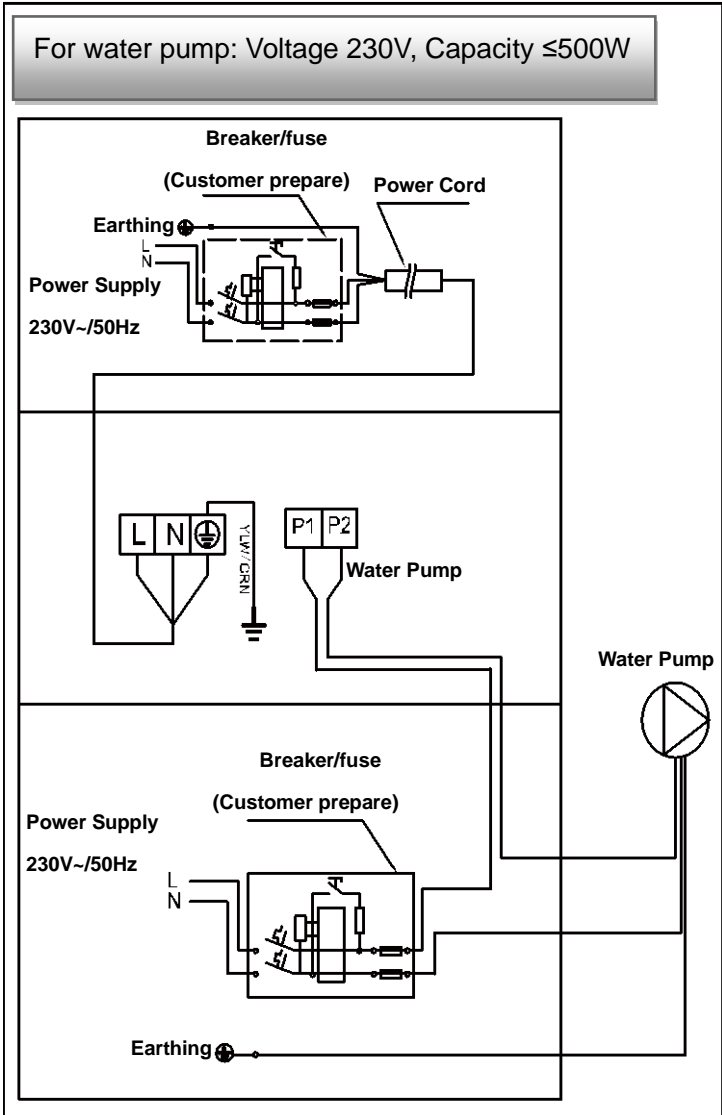

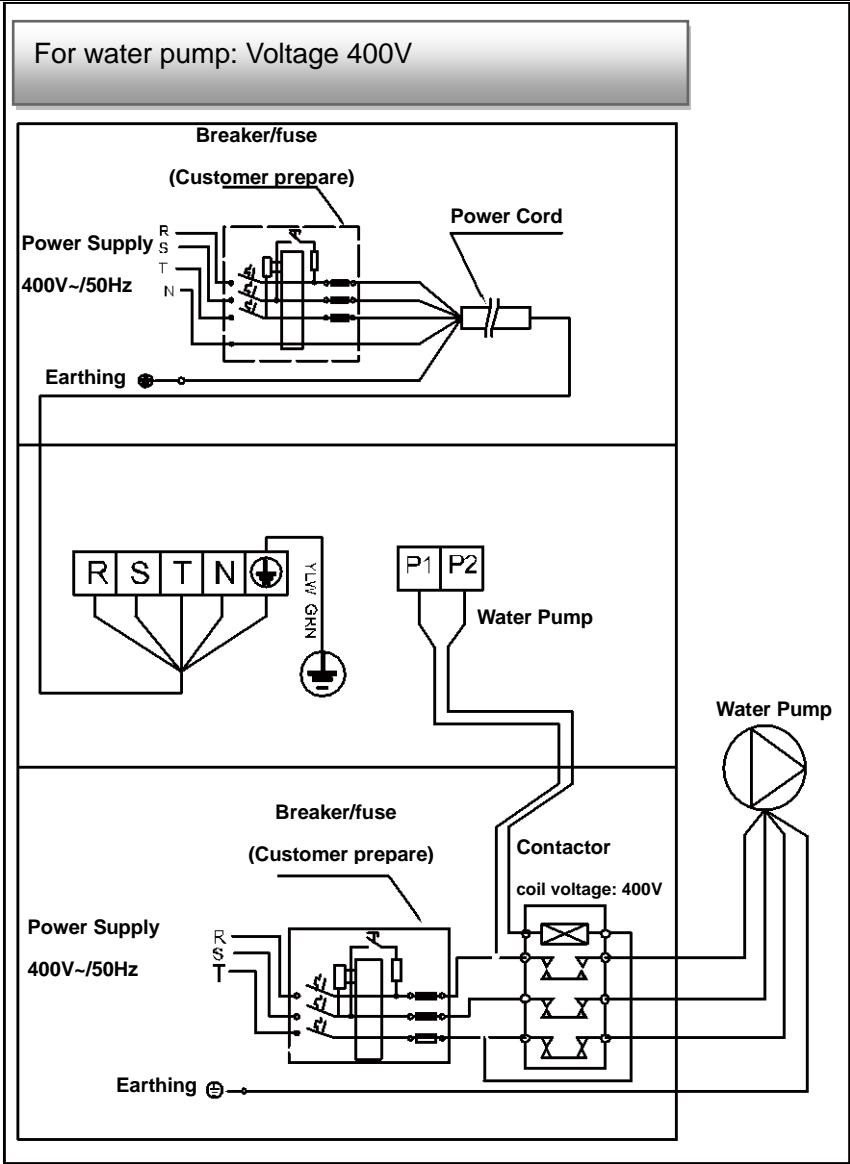

Parallel connection with filtration clock

A: Water pump timer

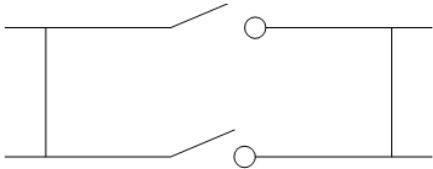

B: Water pump wiring of Heat Pump

Note: The installer should connect A parallel with B (as above picture). To start the water pump, condition A or B is connected. To stop the water pump, both A and B should be disconnected.

Note:

## 5. Wifi setting

### 7) APP Download

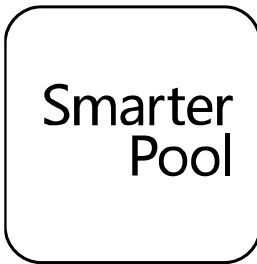

Android mobile please download from



iphone please download from



### 8) Account registration

c) Registration by Cell phone number/Email

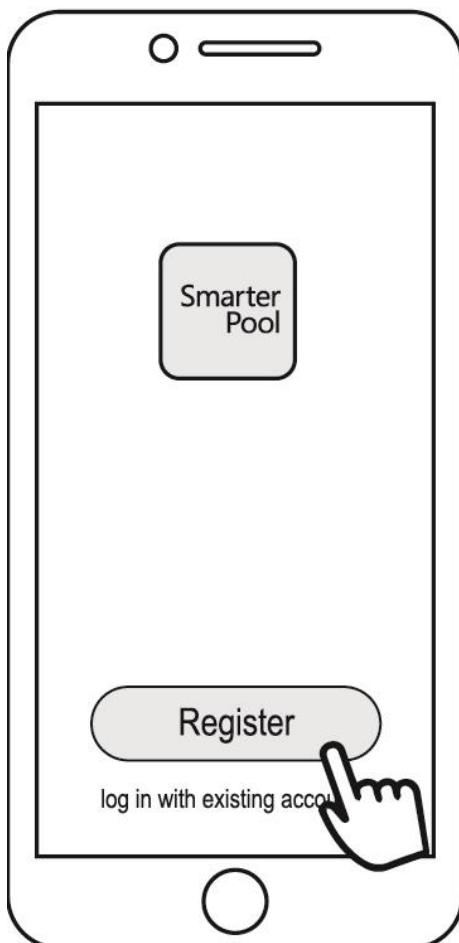

d) Cell phone number registration

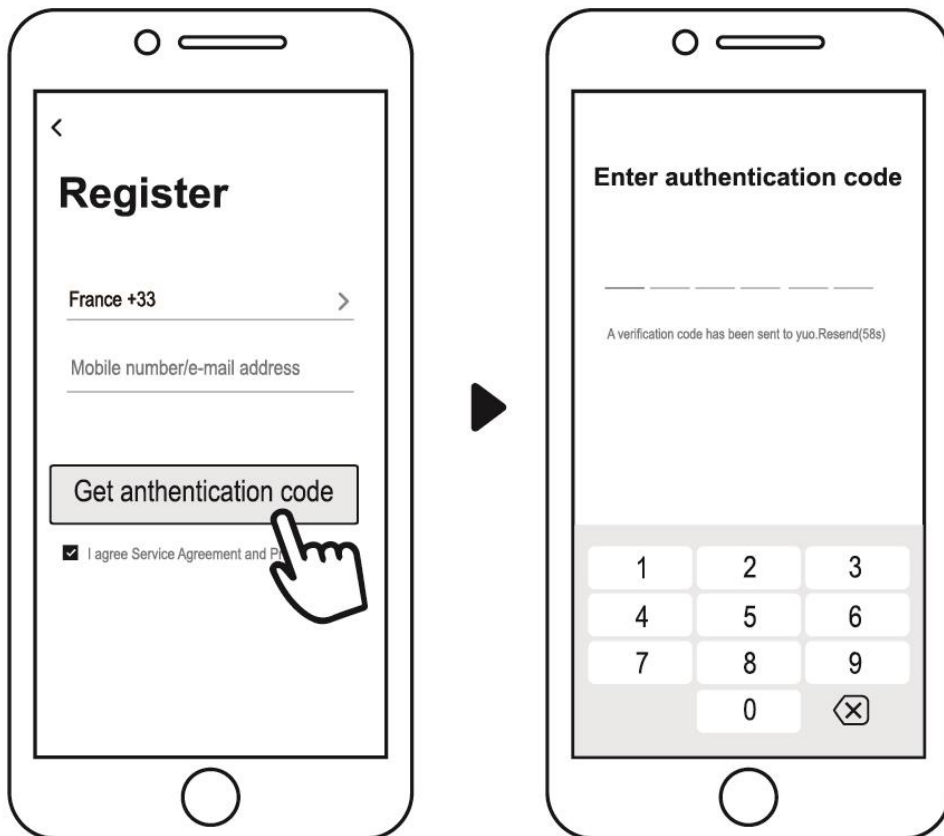

9) Create family



Please set family name and choose the room of device



## 10) APP Binding

Please make sure your cell phone has connected the Wifi

e) Wifi connection:

Press  for 3 seconds after screen unlock,  will be flashing to enter Wifi binding program.



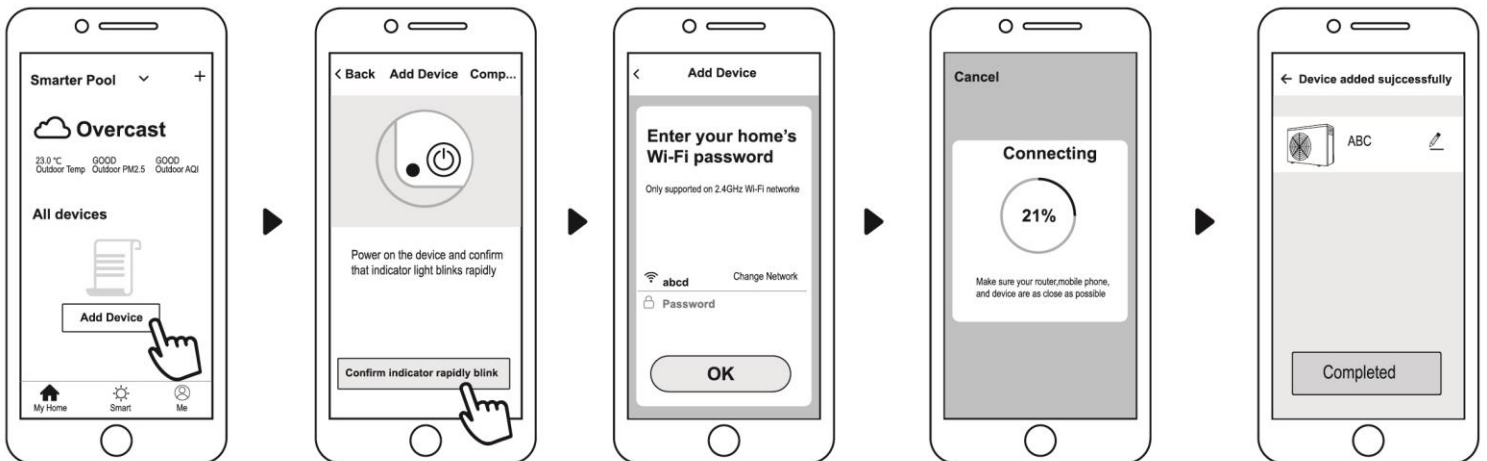

f) Click "Add device", follow indication to finish binding.  display on the screen once Wifi connection success.



g) If connect fails, please make sure your network name and password is correct. And your router, mobile phone and device are as close as possible.

h) Wifi rebinding (When Wifi password changes or network configuration changes):

Press  for 10 seconds,  will be flashing slowly for 60 seconds. Then  will be off. The original binding will be removed. Follow step above for rebinding.

Remarks: Please make sure the router is configured at 2.4G.

11) Operation

For heat pump with Heating function only.

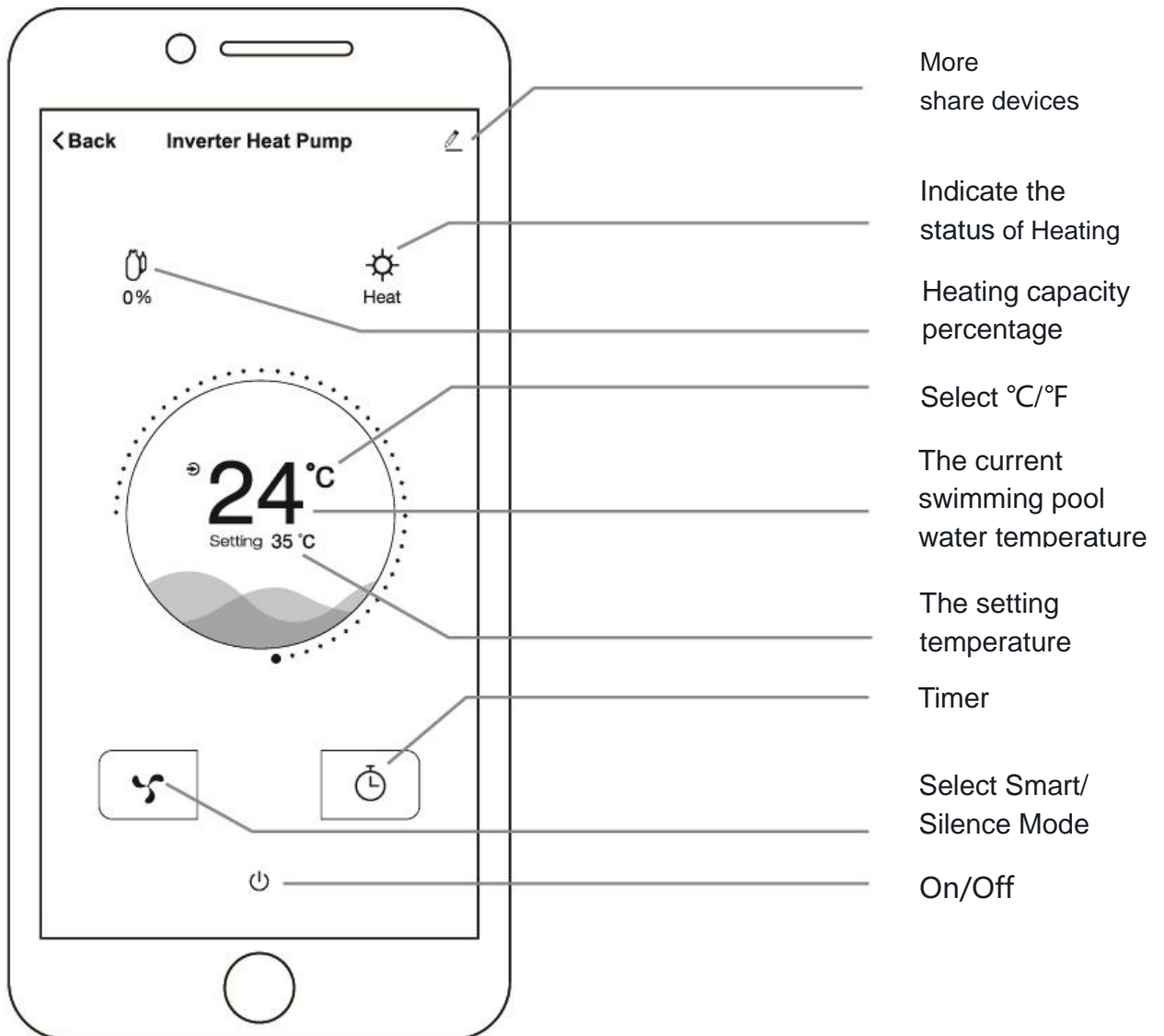

12) Share devices to your family members

After binding, if your family members also want to control the device.

Please let your family members register the APP first, and then the administrator can operate as below:



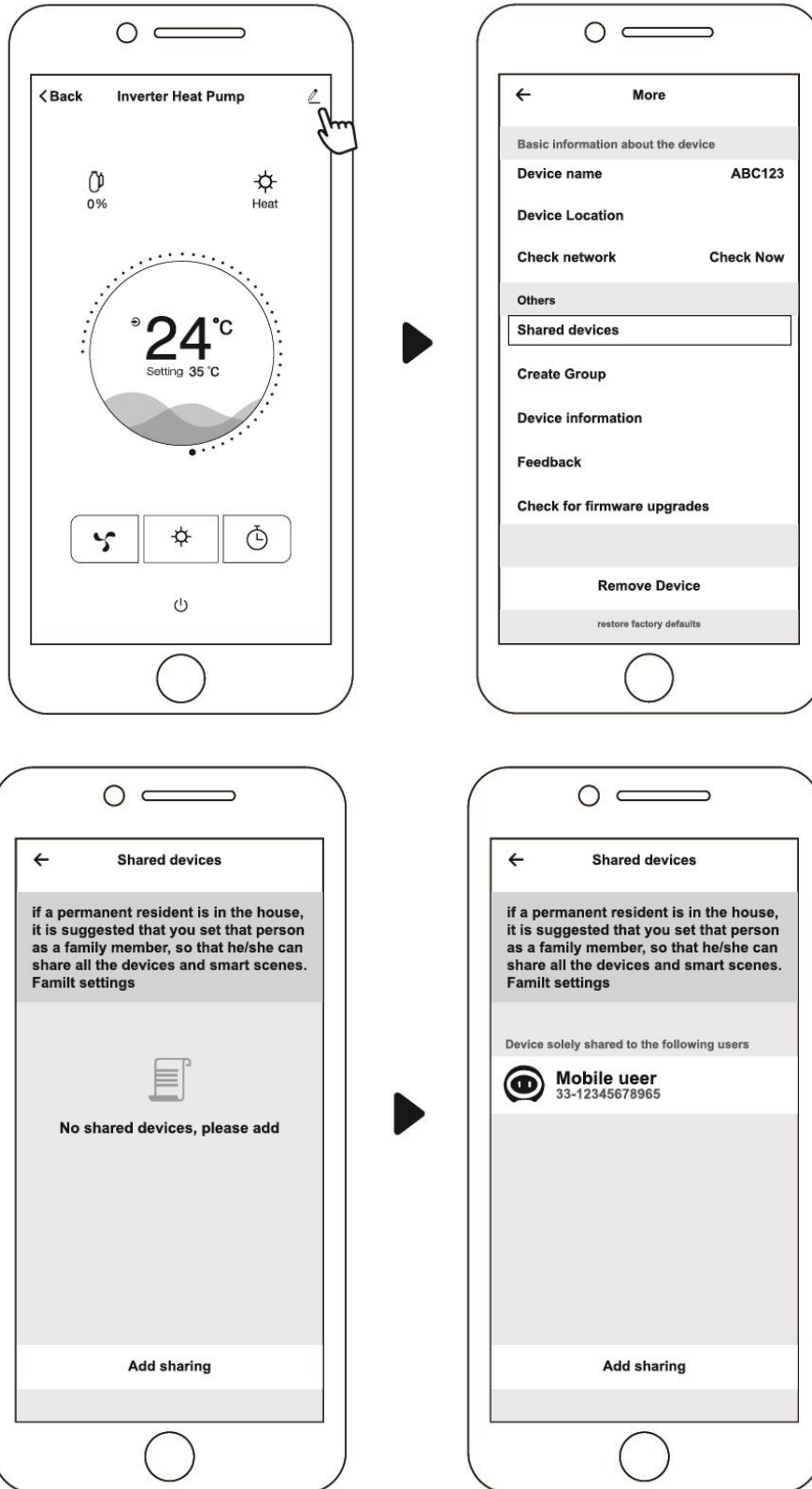

Then your family members can log in as below:

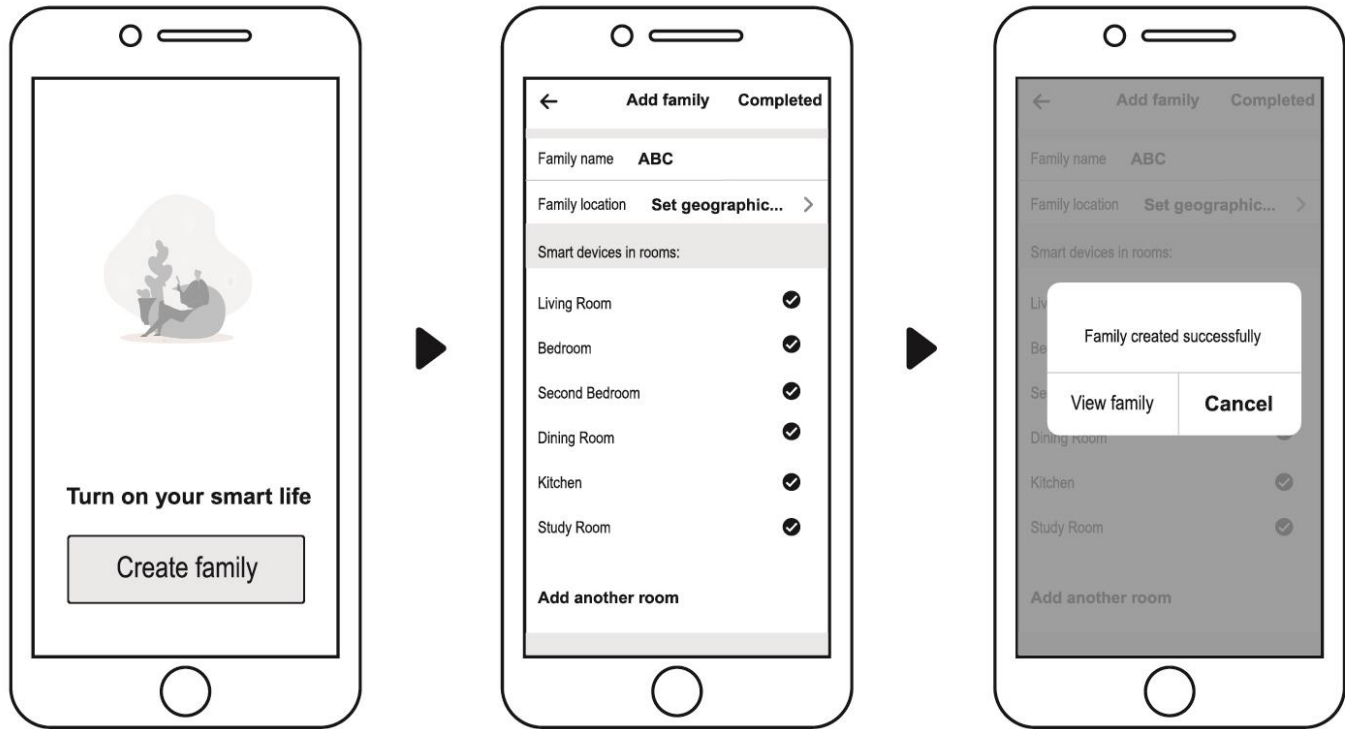

- Notice: 1. The weather forecast is just for reference.  
2. APP is subject to updating without notice.

