

# **SWIMMING POOL HEAT PUMP UNIT**

**Installation & Instruction Manual**

**i-Expertline Wood**





# CONTENTS

1. Preface .....	1
2. Specifications .....	4
2.1 Performance Data of Swimming Pool Heat Pump Unit .....	4
2.2 Dimensions for Swimming Pool Heat Pump Unit .....	6
3. Installation and Connection .....	8
3.1 Swimming Pool Heat Pumps Location .....	8
3.2 How Close to Your Pool? .....	8
3.3 Swimming Pool Heat Pumps Plumbing .....	9
3.4 Swimming Pool Heat Pumps Electrical Wiring .....	10
3.5 Initial Start-up of the Unit .....	10
4. Use and Operation Instruction .....	10
4.1 Interface display .....	11
4.2 Usage of wire controller .....	12
4.3 Clock setting .....	15
4.4 Parameter list and breakdown table .....	17
4.5 Main board .....	20
5. Maintenance and Inspection .....	23
6. Appendix .....	28
6.1 Cable specification .....	28
6.2 Comparison table of refrigerant saturation temperature .....	29

# 1. PREFACE

---

- In order to provide our customers with quality, reliability and versatility, this product has been made to strict production standards. This manual includes all the necessary information about installation, debugging, discharging and maintenance. Please read this manual carefully before you open or maintain the unit. The manufacture of this product will not be held responsible if someone is injured or the unit is damaged, as a result of improper installation, debugging, or unnecessary maintenance. It is vital that the instructions within this manual are adhered to at all times. The unit must be installed by qualified personnel.
- The unit can only be repaired by qualified installer centre, personnel or an authorised dealer.
- Maintenance and operation must be carried out according to the recommended time and frequency, as stated in this manual.
- Use genuine standard spare parts only.  
Failure to comply with these recommendations will invalidate the warranty.
- Swimming Pool Heat Pump Unit heats the swimming pool water and keeps the temperature constant. For split type unit, The indoor unit can be discretely hidden or semi-hidden to suit a luxury house.

Our heat pump has following characteristics:

## 1 Durable

The heat exchanger is made of PVC & Titanium tube which can withstand prolonged exposure to swimming pool water.

## 2 Installation flexibility

The unit can be installed outdoors.

## 3 Quiet operation

The unit comprises an efficient rotary/ scroll compressor and a low-noise fan motor, which guarantees its quiet operation.

## 4 Advanced controlling

The unit includes micro-computer controlling, allowing all operation parameters to be set. Operation status can be displayed on the LCD wire controller. Remote controller can be chosen as future option.

## ● WARNING

Do not use means to accelerate the defrosting process or to clean, Other than those recommended by the manufacturer.

The appliance shall be stored in a room without continuously operating ignition sources (for example: open flames, an operating gas appliance Or an operating electric heater.)

Do not pierce or burn.

Be aware that refrigerants may not contain an odour,

Appliance shall be installed, operated and stored in a room with a floor area larger than 30 m<sup>2</sup>.

NOTE The manufacturer may provide other suitable examples or may provide additional information about the refrigerant odour.



# 1. PREFACE

---

- This appliance can be used by children aged from 8 years and above and persons with reduced physical, sensory or mental capabilities or lack of experience and knowledge if they have been given supervision or instruction concerning use of the appliance in a safe way and understand the hazards involved. Children shall not play with the appliance. Cleaning and user maintenance shall not be made by children without supervision.
- If the supply cord is damaged, it must be replaced by the manufacturer, its service agent or similarly qualified persons in order to avoid a hazard.
- The appliance shall be installed in accordance with national wiring regulations.
- Do not operate your air conditioner in a wet room such as a bathroom or laundry room.
- Before obtaining access to terminals, all supply circuits must be disconnected.
- An all-pole disconnection device which has at least 3mm clearances in all poles, and have a leakage current that may exceed 10mA, the residual current device (RCD) having a rated residual operating current not exceeding 30mA, and disconnection must be incorporated in the fixed wiring in accordance with the wiring rules.
- Do not use means to accelerate the defrosting process or to clean, other than those recommended by the manufacturer
- The appliance shall be stored in a room without continuously operating ignition sources (for example: open flames, an operating gas appliance or an operating electric heater.)
- Do not pierce or burn
- Appliance shall be installed, operated and stored in a room with a floor area larger than 30 m<sup>2</sup>  
Be aware that refrigerants may not contain an odour.  
The installation of pipe-work shall be kept to a minimum 30 m<sup>2</sup>  
Spaces where refrigerant pipes shall be compliance with national gas regulations.  
Servicing shall be performed only as recommended by the manufacturer.  
The appliance shall be stored in a well-ventilated area where the room size corresponds to the room area as specified for operation.  
All working procedure that affects safety means shall only be carried by competent persons.
- Transport of equipment containing flammable refrigerants  
Compliance with the transport regulations  
Marking of equipment using signs  
Compliance with local regulations  
Disposal of equipment using flammable refrigerants  
Compliance with national regulations  
Storage of equipment/appliances  
The storage of equipment should be in accordance with the manufacturer's instructions.  
Storage of packed (unsold) equipment  
Storage package protection should be constructed such that mechanical damage to the equipment inside the package will not cause a leak of the refrigerant charge.  
The maximum number of pieces of equipment permitted to be stored together will be determined by local regulations.

# 1. PREFACE

---

## Caution & Warning

1. The unit can only be repaired by qualified installer centre personnel or an authorised dealer. (for Europe market)
2. This appliance is not intended for use by persons (including children) with reduced physical sensory or mental capabilities, or lack of experience and knowledge, unless they have been given supervision or instruction concerning use of the appliance by a person responsible for their safety. (for Europe market)  
Children should be supervised to ensure that they do not play with the appliance.
3. Please make sure that the unit and power connection have good earthing, otherwise may cause electrical shock.
4. If the supply cord is damaged, it must be replaced by the manufacturer or our service agent or similarly qualified person in order to avoid a hazard.
5. Directive 2002/96/EC (WEEE):  
The symbol depicting a crossed-out waste bin that is underneath the appliance indicates that this product, at the end of its useful life, must be handled separately from domestic waste, must be taken to a recycling centre for electric and electronic devices or handed back to the dealer when purchasing an equivalent appliance.
6. Directive 2002/95/EC (RoHs): This product is compliant with directive 2002/95/EC (RoHs) concerning restrictions for the use of harmful substances in electric and electronic devices.
7. The unit CANNOT be installed near the flammable gas. Once there is any leakage of the gas, fire can occur.
8. Make sure that there is a circuit breaker for the unit, lack of circuit breaker can lead to electrical shock or fire.
9. The heat pump located inside the unit is equipped with an over-load protection system. It does not allow for the unit to start for at least 3 minutes from a previous stoppage.
10. The unit can only be repaired by the qualified personnel of an installer center or an authorized dealer. (for North America market)
11. Installation must be performed in accordance with the NEC/CEC by authorized person only. (for North America market)
12. USE SUPPLY WIRES SUITABLE FOR 75°C.
13. Caution: Single wall heat exchanger, not suitable for potable water connection.

## 2.SPECIFICATION

### 2.1 Performance data of Swimming Pool Heat Pump Unit

\*\*\* REFRIGERANT : R32

UNIT		34-180628	34-180630
Heating capacity (27/24.3℃)	kW	3.622-13.38	4.259-16.67
	Btu/h	12362-45666	14536-56894
Heating Power Input	kW	0.296-2.388	0.271-2.401
COP		12.21-5.60	15.72-6.95
Heating capacity (15/12℃)	kW	2.758-8.447	3.324-11.88
	Btu/h	9413-28829	11345-40546
Heating Power Input	kW	0.467-2.489	0.488-2.524
COP		5.91-3.39	6.81-4.71
Power Supply		220-240V~/50Hz	220-240V~/50Hz
Compressor Quantity		1	1
Compressor		rotary	rotary
Fan Number		1	1
Noise	dB(A)	40-49	43-52
Water Connection	mm	50	50
Water Flow Volume	m <sup>3</sup> /h	6.0	7.3
Water Pressure Drop(max)	kPa	5.5	7.4
Unit Net Dimensions(L/W/H)	mm	See the drawing of the units	See the drawing of the units
Unit Ship Dimensions(L/W/H)	mm	See package lable	See package lable
Net Weight	kg	see nameplate	see nameplate
Shipping Weight	kg	see package label	see package label

Heating: Outdoor airtemp: 27℃/24.3℃, Inlet water temp:26℃

Outdoor air temp: 15℃/12℃, Inlet watertemp:26℃

Operating range:

Ambient temperature:-15—43℃

Water temperature:9-40℃

## 2.SPECIFICATION

### 2.1 Performance data of Swimming Pool Heat Pump Unit

\*\*\* REFRIGERANT : R32

UNIT		34-180632	34-180640
Heating capacity (27/24.3℃)	kW	6.34-20.89	7.68-25.13
	Btu/h	21630-71275	24840-85740
Heating Power Input	kW	0.43-2.80	0.48-4.03
COP		14.77-7.46	16.0-6.24
Heating capacity (15/12℃)	kW	4.65-16.00	5.57-19.2
	Btu/h	15865-54590	19005-65510
Heating Power Input	kW	0.63-2.92	0.80-3.98
COP		7.38-5.48	6.69-4.82
Power Supply		380~415V~/3N/50Hz	380V~/3N/50Hz
Compressor Quantity		1	1
Compressor		rotary	rotary
Fan Number		2	2
Noise	dB(A)	44-50	45-53
Water Connection	mm	50	50
Water Flow Volume	m <sup>3</sup> /h	6.8	9.1
Water Pressure Drop(max)	kPa	5	7.2
Unit Net Dimensions(L/W/H)	mm	See the drawing of the units	See the drawing of the units
Unit Ship Dimensions(L/W/H)	mm	See package lable	See package lable
Net Weight	kg	see nameplate	see nameplate
Shipping Weight	kg	see package label	see package label

Heating: Outdoor airtemp: 27℃/24.3℃, Inlet water temp:26℃

Outdoor air temp: 15℃/12℃, Inlet watertemp:26℃

Operating range:

Ambient temperature:-15—43℃

Water temperature:9-40℃



## 2.SPECIFICATION

---

### 2.1 Performance data of Swimming Pool Heat Pump Unit

\*\*\* REFRIGERANT : R32

UNIT		34-180642
Heating capacity (27/24.3℃)	kW	7.68-29.65
	Btu/h	24840-101165
Heating Power Input	kW	0.48-5.07
COP		16-5.85
Heating capacity (15/12℃)	kW	5.57-22.70
	Btu/h	19005-77450
Heating Power Input	kW	0.80-5.04
COP		6.96-4.50
Power Supply		380V~/3N/50Hz
Compressor Quantity		1
Compressor		rotary
Fan Number		2
Noise	dB(A)	45-54
Water Connection	mm	50
Water Flow Volume	m <sup>3</sup> /h	9.7
Water Pressure Drop(max)	kPa	7.2
Unit Net Dimensions(L/W/H)	mm	See the drawing of the units
Unit Ship Dimensions(L/W/H)	mm	See package lable
Net Weight	kg	see nameplate
Shipping Weight	kg	see package label

Heating: Outdoor airtemp: 27℃/24.3℃, Inlet water temp:26℃

Outdoor air temp: 15℃/12℃, Inlet watertemp:26℃

Operating range:

Ambient temperature:-15—43℃

Water temperature:9-40℃

Pump:The maximum current is no more than 5A.

# 2.SPECIFICATION

---

## 2.2 The dimensions for Swimming Pool Heat Pump Unit

UNIT: 34-180628

34-180630

Unit: mm

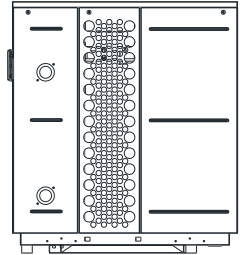
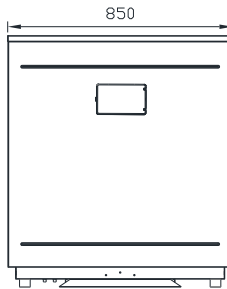
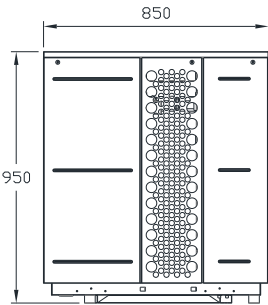
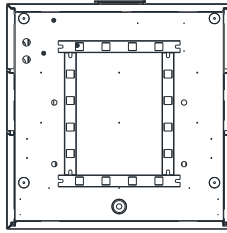

## 2.SPECIFICATION

---

### 2.2 The dimensions for Swimming Pool Heat Pump Unit

UNIT: 34-180632

34-180640

34-180642

Unit: mm

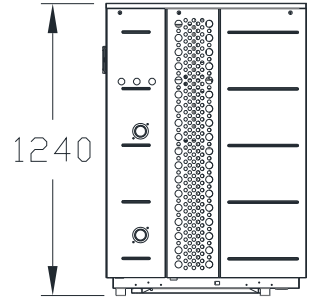
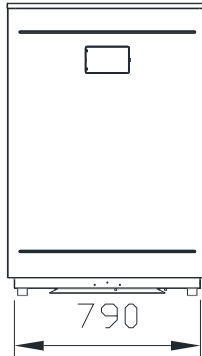
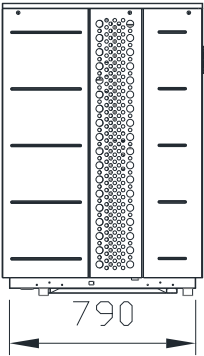
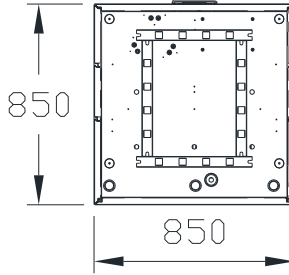

# 3.INSTALLATION AND CONNECTION

---

## 3.1 Swimming Pool Heat Pumps Location

The unit will perform well in any outdoor location provided that the following three factors are presented:

1. Fresh Air -
2. Electricity -
3. Pool filter piping

The unit may be installed virtually anywhere outdoors. For indoor pools please consult the supplier. Unlike a gas heater, it has no draft or pilot light problem in a windy area.

DO NOT place the unit in an enclosed area with a limited air volume, where the units discharge air will be re-circulated.

DO NOT place the unit to shrubs which can block air inlet. These locations deny the unit of a continuous source of fresh air which reduces its efficiency and may prevent adequate heat delivery.

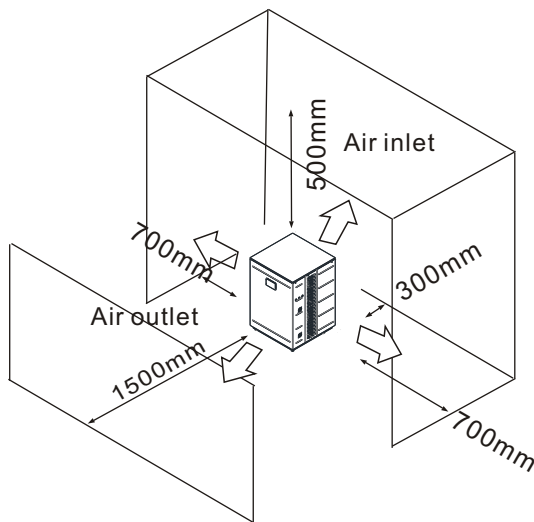

## 3.2 How Close To Your Pool?

Normally, the pool heat pump is installed within 7.5 metres of the pool. The longer the distance from the pool, the greater the heat loss from the piping. For the most part, the piping is buried. Therefore, the heat loss is minimal for runs of up to 15 metres (15 metres to and from the pump = 30 metres total), unless the ground is wet or the water table is high. A very rough estimate of heat loss per 30 metres is 0.6 kW-hour, (2000 BTU) for every 5 °C difference in temperature between the pool water and the ground surrounding the pipe, which translates to about 3% to 5% increase in run time.

# 3.INSTALLATION AND CONNECTION

---

## 3.3 Swimming Pool Heat Pumps Plumbing

The Swimming Pool Heat Pumps exclusive rated flow titanium heat exchanger requires no special plumbing arrangements except bypass (please set the flow rate according to the nameplate). The water pressure drop is less than 10kPa at max. Flow rate. Since there is no residual heat or flame Temperatures, The unit does not need copper heat sink piping. PVC pipe can be run straight into the unit.

Location: Connect the unit in the pool pump discharge (return) line downstream of all filter and pool pumps, and upstream of any chlorinators, ozonators or chemical pumps.

Standard model has slip glue fittings which accept 32mm or 50 mm PVC pipe for connection to the pool or spa filtration piping. By using a 50NB to 40NB you can plumb 40NB

Give serious consideration to adding a quick coupler fitting at the unit inlet and outlet to allow easy draining of unit for winterizing and to provide easier access should servicing be required.

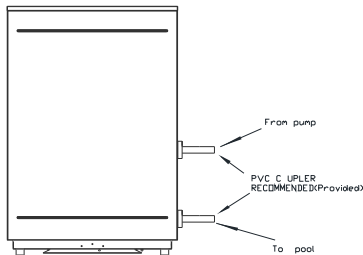

Condensation: Since the Heat pump cools down the air about 4 -5°C, water may condense on the fins of the horseshoe shaped evaporator. If the relative humidity is very high, this could be as much as several litres an hour. The water will run down the fins into the basepan and drain out through the barbed plastic condensation drain fitting on the side of the basepan. This fitting is designed to accept 20mm clear vinyl tubing which can be pushed on by hand and run to a suitable drain. It is easy to mistake the condensation for a water leak inside the unit.

NB: A quick way to verify that the water is condensation is to shut off the unit and keep the pool pump running. If the water stops running out of the basepan, it is condensation. AN EVEN QUICKER WAY IS to TEST THE DRAIN WATER FOR CHLORINE - if there is no chlorine present, then it's condensation.

## 3. INSTALLATION AND CONNECTION

---

### 3.4 Swimming Pool Heat Pumps Electrical Wiring

NOTE: Although the unit heat exchanger is electrically isolated from the rest of the unit, it simply prevents the flow of electricity to or from the pool water. Grounding the unit is still required to protect you against short circuits inside the unit. Bonding is also required.

The unit has a separate molded-in junction box with a standard electrical conduit nipple already in place. Just remove the screws and the front panel, feed your supply lines in through the conduit nipple and wire-nut the electric supply wires to the three connections already in the junction box (four connections if three phase). To complete electrical hookup, connect Heat Pump by electrical conduit, UF cable or other suitable means as specified (as permitted by local electrical authorities) to a dedicated AC power supply branch circuit equipped with the proper circuit breaker, disconnect or time delay fuse protection.

Disconnect - A disconnect means (circuit breaker, fused or un-fused switch) should be located within sight of and readily accessible from the unit. This is common practice on commercial and residential air conditioners and heat pumps. It prevents remotely-energizing unattended equipment and permits turning off power at the unit while the unit is being serviced.

### 3.5 Initial startup of the Unit

NOTE- In order for the unit to heat the pool or spa, the filter pump must be running to circulate water through the heat exchanger.

Start up Procedure - After installation is completed, you should follow these steps:

1. Turn on your filter pump. Check for water leaks and verify flow to and from the pool.
2. Turn on the electrical power supply to the unit, then press the key ON/OFF of wire controller. It should start in several seconds.
3. After running a few minutes make sure the air leaving the top(side) of the unit is cooler (Between 5-10 °C)
4. With the unit operating turn the filter pump off. The unit should also turn off automatically,
5. Allow the unit and pool pump to run 24 hours per day until desired pool water temperature is reached. When the water-in temperature reaches this setting, the unit will slow down for a period of time, if the temperature is maintained for 45 minutes the unit will turn off. The unit will now automatically restart (as long as your pool pump is running) when the pool temperature drops more than 0.2 below set temperature.

Time Delay- The unit is equipped with a 3 minute built-in solid state restart delay included to protect control circuit components and to eliminate restart cycling and contactor chatter. This time delay will automatically restart the unit approximately 3 minutes after each control circuit interruption. Even a brief power interruption will activate the solid state 3 minute restart delay and prevent the unit from starting until the 5 minute countdown is completed.

## 4. OPERATION AND USE

### 4.1. Color screen wire controller interface introduction

#### 4.1.1 Main interface

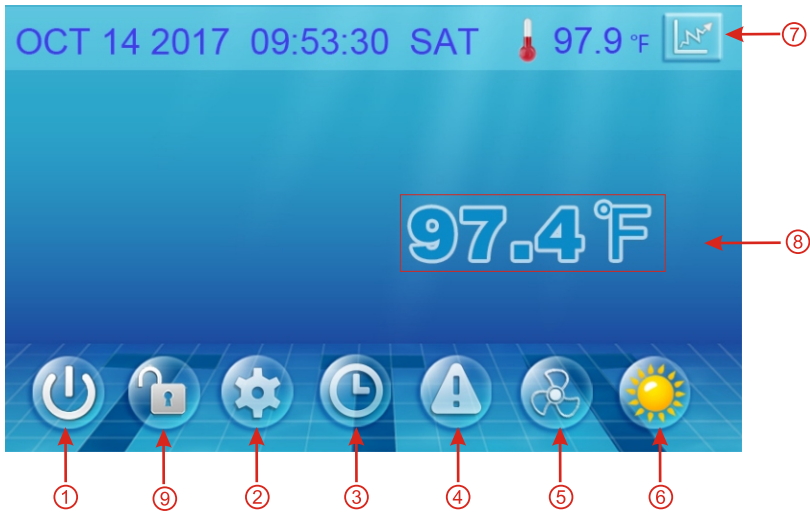

#### 4.1.2 Button Description

NO.	Name	The button function
①	ON/OFF	Press to start/shut off the unit
②	Parameter	Click this button to view the unit state and the parameter
③	CLOCK	Press to set the clock, the timer on or timer off. When the timer was starting, the button is green
④	Fault display	Click to view fault history
⑤	Silent setting	Click to turn on/off silent function and to set timing Low speed function.
⑥	MODE	Click to enter mode setting and the target temp. Setting interface
⑦	Temp. curve	Click to view the temp. and power curve
⑧	Water Inlet Temp.	Click to enter mode setting and the target temp. Setting interface
⑨	LOCK	Click to lock the screen , Input "22" to unlock the screen by press the "lock button"

## 4. OPERATION AND USE

---

### 4.2. Color screen wire controller function introduction

#### 4.2.1 Booting and shutdown

As shown in figure 1.1:

In shutdown status, click ① then the unit will be booted

In booting status, click ① then the unit will be shut down.

#### 4.2.2 Mode switch and target temperature Setting

##### 4.2.2 1 Mode switch

In the main interface, click mode button or inlet water temperature setting button, interface displays as follows:

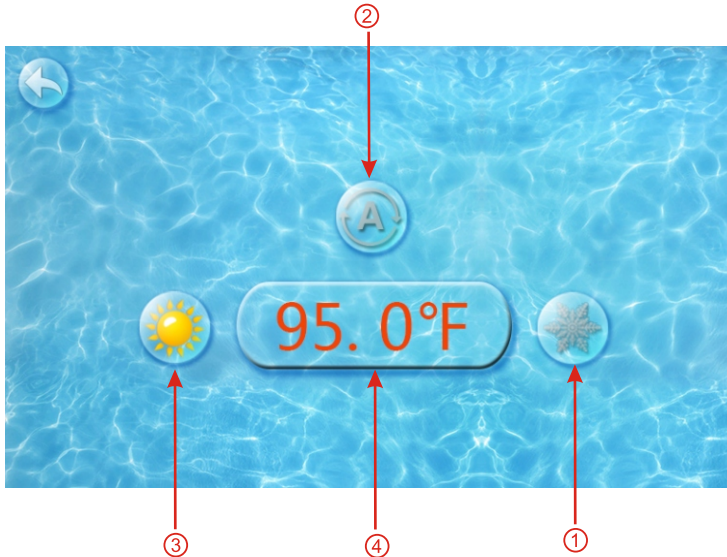

Click the refrigeration mode button ①, automatic mode button ② or heating mode button ③ then you can select the corresponding mode.

Note: when the unit is designed for single automatic mode or single thermal mode, the mode can not be switched.

##### 2.2 2 Target temp. setting

Click the temperature set button ④, you can set the target temperature.



## 4. OPERATION AND USE

---

### 2.3 Clock setting

In the main interface, click on the clock Settings button, interface displays as follows:

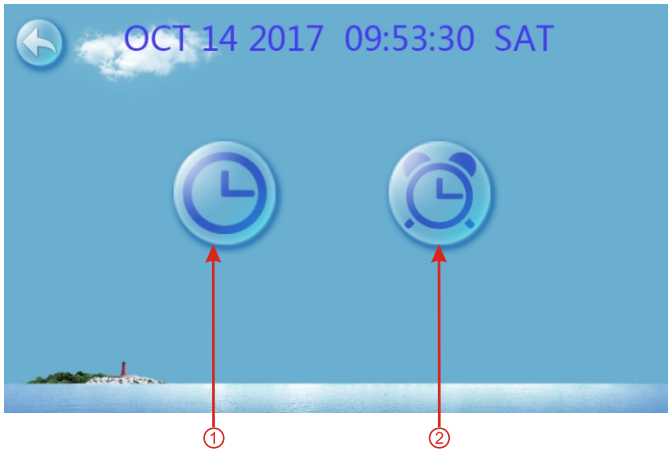

#### 2.3.1 The operation of time setting

Click on the time Settings button ①, interface displays as follows:



Click the value to set time directly, the click confirm button to save the Settings.

For example: setup time: the 10-14-2017 09:21:30, input 10 14 17 09 21 30, the time change then click confirm button.

## 4. OPERATION AND USE

### 2.3.2 The operation of timing setting

Click the timing set button ② to enter timing set interface.

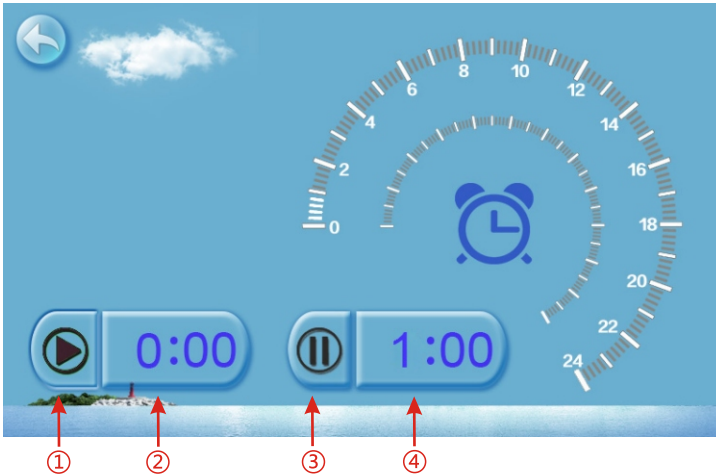

NO.	Name	Button color	Button function
①	Timing start button	Start: green End: gray	Click this button to start or end timing start setting function
②	Timing on setting		Click to set start time of the timing
③	Timing end button	Open: red End: gray	Click this button to start or end timing end setting function
④	Timing off setting		Click to set end time of the timing

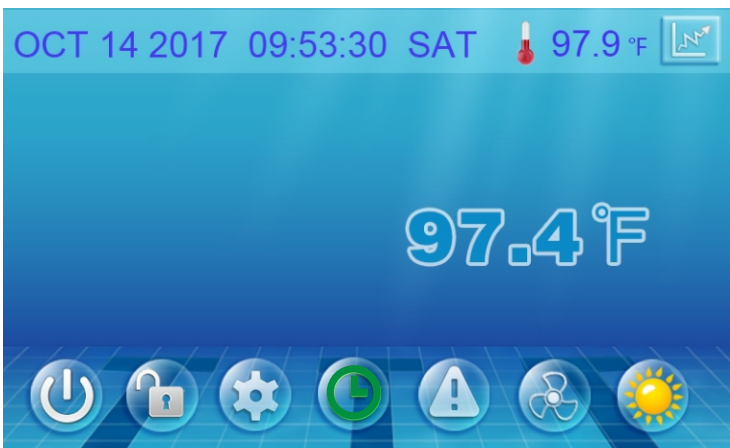

When the timer was starting, the clock button is green in the main interface.

## 4. OPERATION AND USE

### 2.4 Silent setting and silent timing setting

Click the silent setting button, and the interface displays as follows:

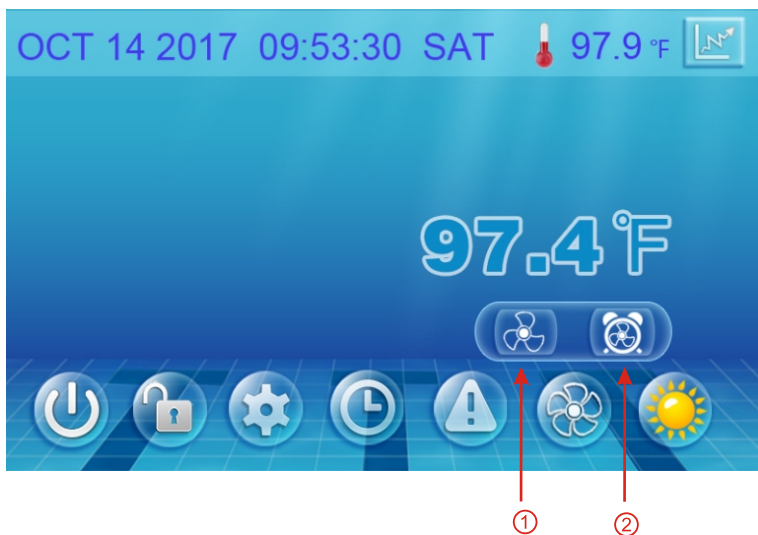

#### 2.4.1 The silent button

Click the silent button ①, the unit will enter the silent mode, and interface displays as follows:

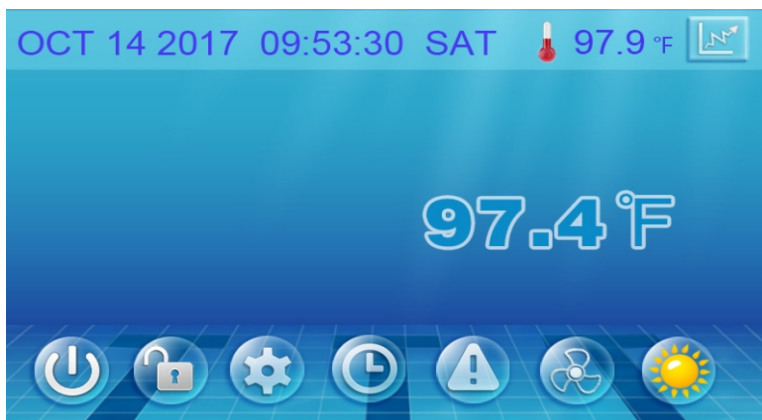

Click the silent button ① again, to exit the silent mode.

## 4. OPERATION AND USE

### 2.4.2 Timing silent function setting

Click timing silent button ②, and interface displays as follows:

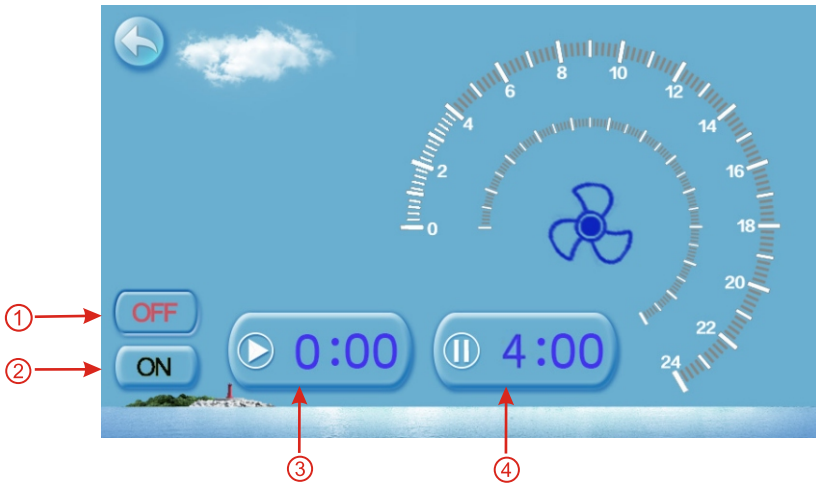

NO.	Name	Colour	Function
①	Timing silent off	Used: red Unused: gray	Click to use or unuse timing off function
②	Timing silent on	Use: green Unused: gray	Click to use or unuse timing on function
③	Timing silent start time		Click this button to set the timing silent start time
④	Timing silent end time		Click this button to set the timing silent end time

Start time and end time setting value must be among the range of 0:00-23:00, and setting value can be precise to hour digit.

For example above, click "ON" to use timing silent, the unit will start the silent at 0:00 points and end at 4:00; click "OFF" to unuse the timing silent, but if the unit is in timing silent mode, it will exit silent timing immediately.

---

## 2.5 History of the fault

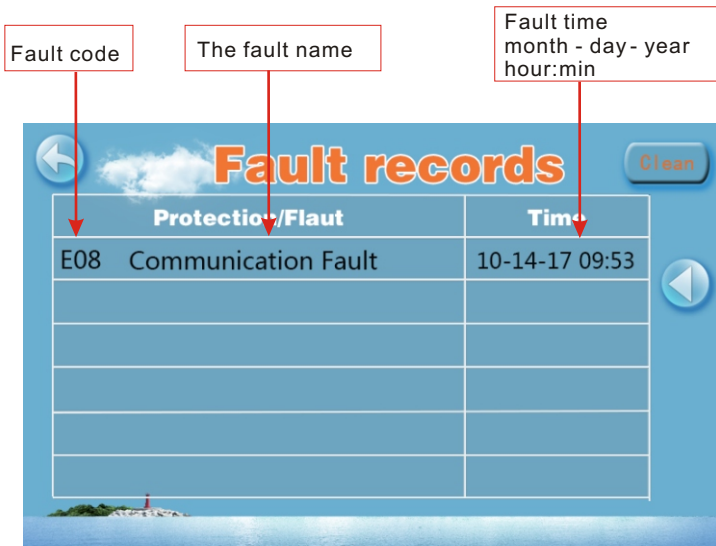

If no failure, main interface displays static "⚠"

When fault occurs, the fault icon will flash between the "⚠" "⚠", the failure interface will record time, code, name of the fault.

After troubleshooting, if you do not check the failure record, the main interface will display static "⚠"; if you check the failure record, the main interface will display static "⚠";

Failure record is in reverse order, according to the happening time.

Press the "Clean" key, you can delete the fault record.

## 2.6 Color Display Calibration

Keep click quickly at the blank area on any interface till you hear a long beep. Then you will enter the calibration interface. Click "+" to start calibration. When you hear the beep again, you will finish calibration and exit.

## 4. Use and Operation Instruction

### 2.7 Temperature curve

In the main interface, click the curve display button, interface displays as follows:

2.7.1 Temperature recording curve is as follows:

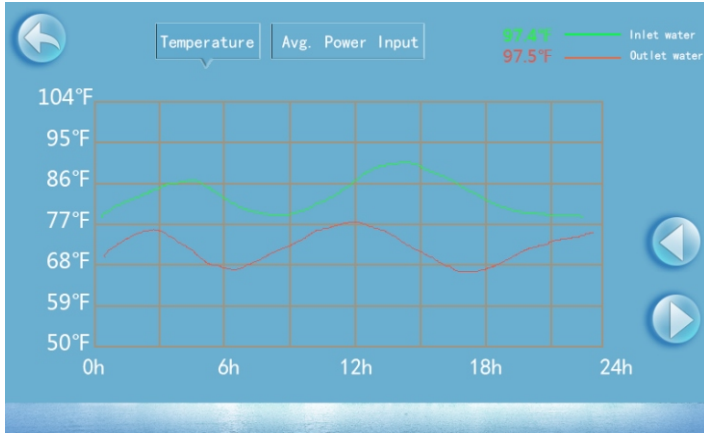

2.7.2 The average power curve

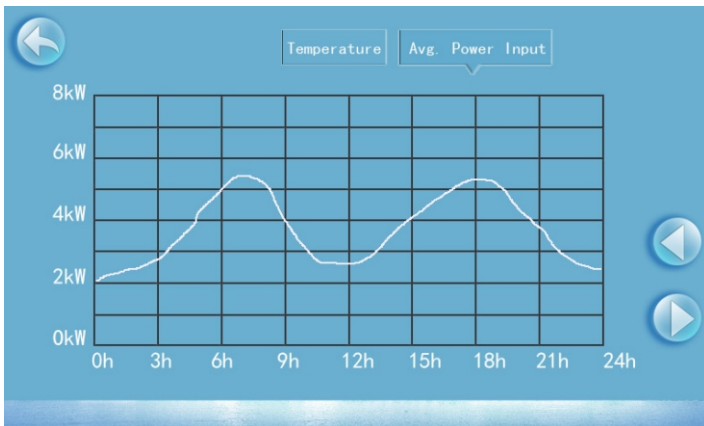

Temperature curve automatically updates every one hour, and the curve record can be stored for 60 days;

Start from the latest curve saved time, if power is off and curve datacollecting time is less than one hour, the data in this period will not be saved;

## 4. Use and Operation Instruction

### 4.3 . Parameter list and breakdown table

#### 10.1 Electronic control fault table

Can be judged according to the remote controller failure code and troubleshooting

Protect/fault	Fault display	Reason	Elimination methods
Standby	Non		
Normal boot	Non		
Inlet Temp. Sensor Fault	P01	The temp. Sensor is broken or short circuit	Check or change the temp. Sensor
Outlet Temp. Sensor Fault	P02	The temp. Sensor is broken or short circuit	Check or change the temp. Sensor
Ambient Temp. Sensor Fault	P04	The temp. Sensor is broken or short circuit	Check or change the temp. Sensor
Coil Temp. Sensor Fault	P05	The temp. Sensor is broken or short circuit	Check or change the temp. Sensor
Suction Temp. Sensor Fault	P07	The temp. Sensor is broken or short circuit	Check or change the temp. Sensor
Discharge Temp. Sensor Fault	P081	The temp. Sensor is broken or short circuit	Check or change the temp. Sensor
High Pressure Prot.	E01	The high-pressure switch is broken	Check the pressure switch and cold circuit
Low Pressure Prot.	E02	Low pressure protection	Check the pressure switch and cold circuit
Flow Switch Prot.	E03	No water/little water in water system	Check the pipe water flow and water pump
Anti-freezing Prot	E07	Water flow is not enough	Check the pipe water flow and whether water system is jammed or not
Primary Anti-freezing Prot.	E19	The ambient temp. is low	
Secondary Anti-freezing Prot.	E29	The ambient temp. is low	
Inlet and outlet temp. too big	E06	Water flow is not enough and low differential pressure	Check the pipe water flow and whether water system is jammed or not
Low temperature protection	Non	The environment temp. is low	
Comp. Overcurrent Prot.	E051	The compressor is overload	Check whether the system of the compressor running normally
Exhaust Air over Temp Prot.	P082	The compressor is overload	Check whether the system of the compressor running normally
Communication Fault	E08	Communication failure between wire controller and mainboard	Check the wire connection between remote wire controller and main board
Antifreeze Temp. Sensor Fault	P09	antifreeze temp sensor is broken or short circuited	check and replace this temp sensor
Waterway Anti-freezing Prot.	E05	water temp. or ambient temp. is too low	
EC fan feedback Fault	F051	There is something wrong with fan motor and fan motor stops running	Check whether fan motor is broken or locked or not
Pressure sensor Fault	PP	The pressure Sensor is broken	Check or change the pressure Sensor or pressure
Fan Motor 1 Fault	F031	1. Motor is in locked-rotor state 2. The wire connection between DC-fan motor module and fan motor is in bad contact	1. Change a new fan motor 2. Check the wire connection and make sure they are in good contact
Low ATProtection	TP	Ambient temp is too low	

## 4. Use and Operation Instruction

FanMotor2Fault	F032	1. Motor is inlocked-rotor state 2. The wire connection between DC-fan motor module and fan motor is in badcontact	1. Change a new fan motor 2. Check the wire connection and make sure they are in good contact
Communication Fault (speed control module)	E081	Speedcontrolmodule andmain boardcommunicationfail	Checkthe communication connection

### Frequency conversion board fault table:

Protection/fault	Fault display	Reason	Elimination methods
Drv1 MOP alarm	F01	MOP drive alarm	Recoveryafter the 150s
Inverter offline	F02	Frequency conversion board and main board communication failure	Checkthe communicationconnection
IPM protection	F03	IPM modular protection	Recoveryafter the 150s
Comp. Driver Failure	F04	Lack of phase, step or drive hardware damage	Checkthe measuringvoltage check requencyconversion board hardware
DC Fan Fault	F05	Motor current feedback open circuit or short circuit	Checkwhether currentreturn wires connectedmotor
IPM Overcurrent	F06	IPM Input current is large	Checkand adjustthe current measurement
Inv. DC Overvoltage	F07	DC bus voltage>Dc bus over-voltage protection value	Checkthe input voltagemasurement
Inv. DC Lessvoltage	F08	DC bus voltage<Dc bus over-voltage protection value	Checkthe input voltagemasurement
Inv. Input Lessvolt.	F09	The input voltage is low, causing the inputcurrent is high	Checkthe input voltagemasurement
Inv. Input Overvolt.	F10	The input voltage is too high, more than outage protection current RMS	Checkthe input voltagemasurement
Inv. Sampling Volt.	F11	The input voltage sampling fault	Checkand adjustthe current measurement
Comm. Err DSP-PFC	F12	DSP and PFC connect fault	Checkthe communicationconnection
Input Over Cur.	F26	The equipment load is too large	
PFC fault	F27	The PFC circuit protection	Check the PFC switch tube short circuit or not
IPM Over heating	F15	The IPM module is overheat	Checkand adjustthe current measurement
Weak Magnetic Warn	F16	Compressor magnetic force is not enough	
Inv. Input OutPhase	F17	The input voltage lost phase	Checkand measurethe voltage adjustment
IPM Sampling Cur.	F18	IPM sampling electricity is fault	Checkand adjustthe current measurement
Inv. Temp. Probe Fail	F19	Sensor is short circuit or open circuit	Inspectand replacethe sensor
Inverter Overheating	F20	The transducer is overheat	Checkand adjustthe current measurement
Inv. Overheating Warn	F22	Transducer temperature is too high	Checkand adjustthe current measurement
Comp. OverCur. Warn	F23	Compressor electricity is large	The compressorover-current protection
Input Over Cur. Warn	F24	Input current is too large	Checkand adjustthe current measurement
EEPROM Error Warn	F25	MCU error	Checkwhether the chip is damaged Replacethe chip
V15V over/undervoltage fault	F28	The V15V is overload or undervoltage	Checkthe V15V input voltage in range 13.5v~16.5v or not



# 4. Use and Operation Instruction

## 4.5 . Main board(Q20 )

### Controller interface diagram and definition

#### (2) Parameter list

Meaning	Default	Remarks
Refrigeration target temperature set point	27 °C	Adjustable
Heating the target temperature set point	27 °C	Adjustable
Automatic target temperature set point	27 °C	Adjustable

## 4.4 Interface drawin

### (1) Wire control interface diagram and definition



Sign	Meaning
V	12V ( power + )
R	No use
T	No use
A	485A
B	485B
G	GND(power-)

### (2) Controller interface diagram and definition

UNIT:34-180628

34-180630

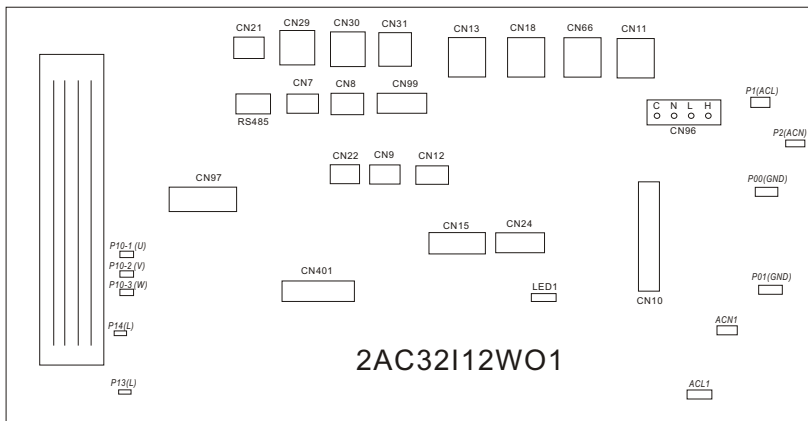

## 4. Use and Operation Instruction

### (2) Controller interface diagram and definition

UNIT: 34-180632

34-180640

34-180642

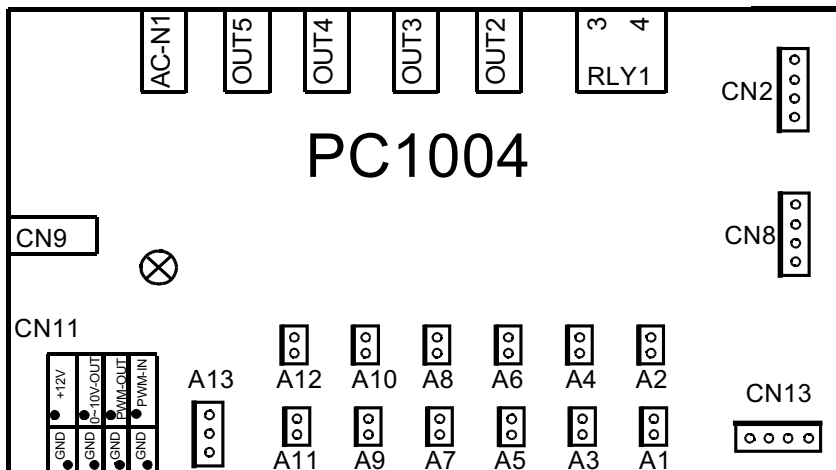

## 4. Use and Operation Instruction

Main board of the input and output interface instructions below: 2AC3211WO1

Number	Sign	Meaning
01	P10-1/2/3(U/V/W)	Compressor
02	CN66	Compressor signal
03	CN97	DC motor
04	CN11	4-way valve
05	CN18	Water pump
06	CN13	reserved
07	CN96-H	High speed of fan
08	CN96-L	Low speed of fan
09	CN24	Electronic expansion valve
10	P1 P2	Live wire Neutral wire
11	ACL1 ACN1	Switching power module
12	CN10	Program download interface
13	CN401	reserved
14	CN15	reserved
15	P13(L)/P14(L)	resistance
16	P00/P01/P03	ground
17	RS485	Color line controller communication
18	CN29	Water flow switch
19	CN30	System high pressure
20	CN31	System low pressure
21	CN21	Water input temperature
22	CN7	System suction temperature
23	CN8	System fan coil temperature
24	CN99	Low pressure sensor
25	CN22	Water output temperature
26	CN9	System Exhaust temperature
27	CN12	Ambient temperature

## 4. Use and Operation Instruction

Main board of the input and output interface instructions below:PC1004

Number	Sign	Meaning
01	OUT1	Compressor ( output220-230VAC )
02	OUT2	Water pump ( output 220-230VAC )
03	OUT3	4-way valve (output 220-230VAC )
04	OUT4	High speed of fan ( output220-230VAC )
05	OUT5	Low speed of fan (output 220-230VAC )
06	AC-L	Live wire (input 220-230VAC )
07	AC-N	Neutral wire (input 220-230VAC )
08	AI/DI01	Emergency switch ( input )
09	AI/DI02	Water flow switch ( input )
10	AI/DI03	System low pressure ( input )
11	AI/DI04	System high pressure ( input )
12	AI/DI05	System suction temperature ( input )
13	AI/DI06	Water input temperature ( input )
14	AI/DI07	Water output temperature ( input )
15	AI/DI08	System fan coil temperature ( input )
16	AI/DI09	Ambient temperature ( input )
17	AI/DI10	Mode switch ( input )
18	AI/DI11	Master-slave machine switch/ Antifreeze temperature ( input )
19	AI12(50K)	System Exhaust temperature ( input )
20	0_5V_IN	Compressor current detection/Pressure sensor(input)
21	PWM_IN	Master-slave machine switch/ Feedback signal of EC fan ( input )
22	PWM_OUT	AC fan control( output )
23	0_10V_OUT	EC fan control( output )
24	+5V	+5V ( output )
25	+12V	+12V ( output )
26	GND	Frequency conversion board communications
27	485_B1	
28	485_A1	
29	12V	
30	GND	Color line controller communication
31	485_B2	
32	485_A2	
33	12V	
34	CN9	Electronic expansion valve
35	GND	The port for centralized control system
36	485_B3	
37	485_A3	
38	12V	

## 5. MAINTENANCE AND INSPECTION

- Check the water supply device and the release often. You should avoid the condition of no water or air entering into system, as this will influence unit's performance and reliability. You should clear the pool/spa filter regularly to avoid damage to the unit as a result of the dirty or clogged filter.
- The area around the unit should be dry, clean and well ventilated. Clean the side heating exchanger regularly to maintain good heat exchange as conserve energy .
- The operation pressure of the refrigerant system should only be serviced by a certified technician .
- Check the power supply and cable connection often. Should the unit begin to operate abnormally, switch it off and contact the qualified technician.
- Discharge all water in the water pump and water system ,so that freezing of the water in the pump or water system does not occur. You should discharge the water at the bottom of water pump if the unit will not be used for an extended period of time. You should check the unit thoroughly and fill the system with water fully before using it for the first time after a
- Checks to the area  
Prior to beginning work on systems containing flammable refrigerants, safety checks are necessary to ensure that the risk of ignition is minimised. For repair to the refrigerating system, the following precautions shall be complied with prior to conducting work on the system. prolonged period of no usage.
- Work procedure  
Work shall be undertaken under a controlled procedure so as to minimise the risk of a flammable gas or vapour being present while the work is being performed.
- Work procedure  
Work shall be undertaken under a controlled procedure so as to minimise the risk of a flammable gas or vapour being present while the work is being performed.
- General work area  
All maintenance staff and others working in the local area shall be instructed on the nature of work being carried out. Work in confined spaces shall be avoided. The area around the workspace shall be sectioned off. Ensure that the conditions within the area have been made safe by control of flammable material.
- General work area  
All maintenance staff and others working in the local area shall be instructed on the nature of work being carried out. Work in confined spaces shall be avoided. The area around the workspace shall be sectioned off. Ensure that the conditions within the area have been made safe by control of flammable material.
- Checking for presence of refrigerant  
The area shall be checked with an appropriate refrigerant detector prior to and during work, to ensure the technician is aware of potentially flammable atmospheres. Ensure that the leak detection equipment being used is suitable for use with flammable refrigerants, i.e. non-sparking, adequately sealed or intrinsically safe.
- Presence of fire extinguisher  
If any hot work is to be conducted on the refrigeration equipment or any associated parts, appropriate fire extinguishing equipment shall be available to hand. Have a dry powder or CO2 fire extinguisher adjacent to the charging area.

## 5. MAINTENANCE AND INSPECTION

---

### ● No ignition sources

No person carrying out work in relation to a refrigeration system which involves exposing any pipe work that contains or has contained flammable refrigerant shall use any sources of ignition in such a manner that it may lead to the risk of fire or explosion. All possible ignition sources, including cigarette smoking, should be kept sufficiently far away from the site of installation, repairing, removing and disposal, during which flammable refrigerant can possibly be released to the surrounding space. Prior to work taking place, the area around the equipment is to be surveyed to make sure that there are no flammable hazards or ignition risks. “No Smoking” signs shall be displayed.

### ● Ventilated area

Ensure that the area is in the open or that it is adequately ventilated before breaking into the system or conducting any hot work. A degree of ventilation shall continue during the period that the work is carried out. The ventilation should safely disperse any released refrigerant and preferably expel it externally into the atmosphere. prolonged period of no usage.

### ● Checks to the area

Prior to beginning work on systems containing flammable refrigerants, safety checks are necessary to ensure that the risk of ignition is minimised. For repair to the refrigerating system, the following precautions shall be complied with prior to conducting work on the system. prolonged period of no usage.

### ● Checks to the refrigeration equipment

Where electrical components are being changed, they shall be fit for the purpose and to the correct specification. At all times the manufacturer's maintenance and service guidelines shall be followed. If in doubt consult the manufacturer's technical department for assistance.

The following checks shall be applied to installations using flammable refrigerants:

The charge size is in accordance with the room size within which the refrigerant containing parts are installed;

The ventilation machinery and outlets are operating adequately and are not obstructed;

If an indirect refrigerating circuit is being used, the secondary circuit shall be checked for the presence of refrigerant;

Marking to the equipment continues to be visible and legible. Markings and signs that are illegible shall be corrected;

Refrigeration pipe or components are installed in a position where they are unlikely to be exposed to any substance which may corrode refrigerant containing components, unless the components are constructed of materials which are inherently resistant to being corroded or are suitably protected against being so corroded.

### ● Checks to electrical devices

Repair and maintenance to electrical components shall include initial safety checks and component inspection procedures. If a fault exists that could compromise safety, then no electrical supply shall be connected to the circuit until it is satisfactorily dealt with. If the fault cannot be corrected immediately but it is necessary to continue operation, an adequate temporary solution shall be used. This shall be reported to the owner of the equipment so all parties are advised.

Initial safety checks shall include:

. That capacitors are discharged: this shall be done in a safe manner to avoid possibility of sparking;

. That there no live electrical components and wiring are exposed while charging, recovering or purging the system;

. That there is continuity of earth bonding.

## 5. MAINTENANCE AND INSPECTION

---

### ● Repairs to sealed components

1) During repairs to sealed components, all electrical supplies shall be disconnected from the equipment being worked upon prior to any removal of sealed covers, etc. If it is absolutely necessary to have an electrical supply to equipment during servicing, then a permanently operating form of leak detection shall be located at the most critical point to warn of a potentially hazardous situation.

2) Particular attention shall be paid to the following to ensure that by working on electrical components, the casing is not altered in such a way that the level of protection is affected. This shall include damage to cables, excessive number of connections, terminals not made to original specification, damage to seals, incorrect fitting of glands, etc.

Ensure that apparatus is mounted securely.

### ● Ensure that seals or sealing materials have not degraded such that they no longer serve the purpose of preventing the ingress of flammable atmospheres. Replacement parts shall be in accordance with the manufacturer's specifications.

NOTE: The use of silicon sealant may inhibit the effectiveness of some types of leak detection equipment. Intrinsically safe components do not have to be isolated prior to

### ● Repair to intrinsically safe components

Do not apply any permanent inductive or capacitance loads to the circuit without ensuring that this will not exceed the permissible voltage and current permitted for the equipment in use.

Intrinsically safe components are the only types that can be worked on while live in the presence of a flammable atmosphere. The test apparatus shall be at the correct rating.

Replace components only with parts specified by the manufacturer. Other parts may result in the ignition of refrigerant in the atmosphere from a leak.

### ● Cabling

Check that cabling will not be subject to wear, corrosion, excessive pressure, vibration, sharp edges or any other adverse environmental effects. The check shall also take into account the effects of aging or continual vibration from sources such as compressors or fans.

### ● Detection of flammable refrigerants

Under no circumstances shall potential sources of ignition be used in the searching for or detection of refrigerant leaks. A halide torch (or any other detector using a naked flame) shall not be used.

### Leak detection methods

The following leak detection methods are deemed acceptable for systems containing flammable refrigerants.

### ● Electronic leak detectors shall be used to detect flammable refrigerants, but the sensitivity may not be adequate, or may need re-calibration. (Detection equipment shall be calibrated in a refrigerant-free area.) Ensure that the detector is not a potential source of ignition and is suitable for the refrigerant used. Leak detection equipment shall be set at a percentage of the LFL of the refrigerant and shall be calibrated to the refrigerant employed and the appropriate percentage of gas (25 % maximum) is confirmed.

Leak detection fluids are suitable for use with most refrigerants but the use of detergents containing chlorine shall be avoided as the chlorine may react with the refrigerant and corrode the copper pipe-work.

If a leak is suspected, all naked flames shall be removed/ extinguished.

If a leakage of refrigerant is found which requires brazing, all of the refrigerant shall be recovered from the system, or isolated (by means of shut off valves) in a part of the system remote from the leak. Oxygen free nitrogen (OFN) shall then be purged through the system both before and during the brazing process.

## 5. MAINTENANCE AND INSPECTION

---

### Removal and evacuation

When breaking into the refrigerant circuit to make repairs or for any other purpose conventional procedures shall be used. However, it is important that best practice is followed since flammability is a consideration. The following procedure shall be adhered to:

- . Remove refrigerant;
- . Purge the circuit with inert gas;
- . Evacuate;
- . Purge again with inert gas;
- . Open the circuit by cutting or brazing.

The refrigerant charge shall be recovered into the correct recovery cylinders. The system shall be "flushed" with OFN to render the unit safe. This process may need to be repeated several times. Compressed air or oxygen shall not be used for this task.

Flushing shall be achieved by breaking the vacuum in the system with OFN and continuing to fill until the working pressure is achieved, then venting to atmosphere, and finally pulling down to a vacuum. This process shall be repeated until no refrigerant is within the system. When the final OFN charge is used, the system shall be vented down to atmospheric pressure to enable work to take place. This operation is absolutely vital if brazing operations on the pipe-work are to take place.

Ensure that the outlet for the vacuum pump is not close to any ignition sources and there is ventilation available when working on them.

### Labelling

Equipment shall be labelled stating that it has been de-commissioned and emptied of refrigerant. The label shall be dated and signed. Ensure that there are labels on the equipment stating the equipment contains flammable refrigerant.

### Recovery

When removing refrigerant from a system, either for servicing or decommissioning, it is recommended good practice that all refrigerants are removed safely.

When transferring refrigerant into cylinders, ensure that only appropriate refrigerant recovery cylinders are employed. Ensure that the correct number of cylinders for holding the total system charge is available. All cylinders to be used are designated for the recovered refrigerant and labelled for that refrigerant (i.e. special cylinders for the recovery of refrigerant). Cylinders shall be complete with pressure relief valve and associated shut-off valves in good working order. Empty recovery cylinders are evacuated and, if possible, cooled before recovery occurs.

The recovery equipment shall be in good working order with a set of instructions concerning the equipment that is at hand and shall be suitable for the recovery of flammable refrigerants. In addition, a set of calibrated weighing scales shall be available and in good working order. Hoses shall be complete with leak-free disconnect couplings and in good condition. Before using the recovery machine, check that it is in satisfactory working order, has been properly maintained and that any associated electrical components are sealed to prevent ignition in the event of a refrigerant release. Consult manufacturer if in doubt.

The recovered refrigerant shall be returned to the refrigerant supplier in the correct recovery cylinder, and the relevant Waste Transfer Note arranged. Do not mix refrigerants in recovery units and especially not in cylinders.

If compressors or compressor oils are to be removed, ensure that they have been evacuated to an acceptable level to make certain that flammable refrigerant does not remain within the lubricant. The evacuation process shall be carried out prior to returning the compressor to the suppliers. Only electric heating to the compressor body shall be employed to accelerate this process. When oil is drained from a system, it shall be carried out safely.



## 5. MAINTENANCE AND INSPECTION

---

### ● Decommissioning

Before carrying out this procedure, it is essential that the technician is completely familiar with the equipment and all its detail. It is recommended good practice that all refrigerants are recovered safely. Prior to the task being carried out, an oil and refrigerant sample shall be taken in case analysis is required prior to re-use of reclaimed refrigerant. It is essential that electrical power is available before the task is commenced.

a) Become familiar with the equipment and its operation.

b) Isolate system electrically.

c) Before attempting the procedure ensure that:

. Mechanical handling equipment is available, if required, for handling refrigerant cylinders;

. All personal protective equipment is available and being used correctly;

. The recovery process is supervised at all times by a competent person;

. Recovery equipment and cylinders conform to the appropriate standards.

d) Pump down refrigerant system, if possible.

e) If a vacuum is not possible, make a manifold so that refrigerant can be removed from various parts of the system.

f) Make sure that cylinder is situated on the scales before recovery takes place.

g) Start the recovery machine and operate in accordance with manufacturer's instructions.

h) Do not overfill cylinders. (No more than 80 % volume liquid charge).

i) Do not exceed the maximum working pressure of the cylinder, even temporarily.

j) When the cylinders have been filled correctly and the process completed, make sure that the cylinders and the equipment are removed from site promptly and all isolation valves on the equipment are closed off.

k) Recovered refrigerant shall not be charged into another refrigeration system unless it has been cleaned and checked.

### ● Charging procedures

In addition to conventional charging procedures, the following requirements shall be followed.

- Ensure that contamination of different refrigerants does not occur when using charging equipment. Hoses or lines shall be as short as possible to minimise the amount of refrigerant contained in them.

- Cylinders shall be kept upright.

- Ensure that the refrigeration system is earthed prior to charging the system with refrigerant.

- Label the system when charging is complete (if not already).

- Extreme care shall be taken not to overfill the refrigeration system.

Prior to recharging the system it shall be pressure tested with OFN. The system shall be leak tested on completion of charging but prior to commissioning. A follow up leak test shall be carried out prior to leaving the site.

### ● The safety wire model is 5\*20\_5A/250VAC, And must meet the explosion-proof requirements

## 6. APPENDIX

### 6.1 Cable specification

#### (1) Single phase unit

Nameplate maximum current	Phase line	Earth line	MCB	Creepage protector	Signal line
No more than 10A	2×1.5mm <sup>2</sup>	1.5mm <sup>2</sup>	20A	30mA less than 0.1 sec	n×0.5mm <sup>2</sup>
10~16A	2×2.5mm <sup>2</sup>	2.5mm <sup>2</sup>	32A	30mA less than 0.1 sec	
16~25A	2×4mm <sup>2</sup>	4mm <sup>2</sup>	40A	30mA less than 0.1 sec	
25~32A	2×6mm <sup>2</sup>	6mm <sup>2</sup>	40A	30mA less than 0.1 sec	
32~40A	2×10mm <sup>2</sup>	10mm <sup>2</sup>	63A	30mA less than 0.1 sec	
40~63A	2×16mm <sup>2</sup>	16mm <sup>2</sup>	80A	30mA less than 0.1 sec	
63~75A	2×25mm <sup>2</sup>	25mm <sup>2</sup>	100A	30mA less than 0.1 sec	
75~101A	2×25mm <sup>2</sup>	25mm <sup>2</sup>	125A	30mA less than 0.1 sec	
101~123A	2×35mm <sup>2</sup>	35mm <sup>2</sup>	160A	30mA less than 0.1 sec	
123~148A	2×50mm <sup>2</sup>	50mm <sup>2</sup>	225A	30mA less than 0.1 sec	
148~186A	2×70mm <sup>2</sup>	70mm <sup>2</sup>	250A	30mA less than 0.1 sec	
186~224A	2×95mm <sup>2</sup>	95mm <sup>2</sup>	280A	30mA less than 0.1 sec	

#### (2) Three phase unit

Nameplate maximum current	Phase line	Earth line	MCB	Creepage protector	Signal line
No more than 10A	3×1.5mm <sup>2</sup>	1.5mm <sup>2</sup>	20A	30mA less than 0.1 sec	n×0.5mm <sup>2</sup>
10~16A	3×2.5mm <sup>2</sup>	2.5mm <sup>2</sup>	32A	30mA less than 0.1 sec	
16~25A	3×4mm <sup>2</sup>	4mm <sup>2</sup>	40A	30mA less than 0.1 sec	
25~32A	3×6mm <sup>2</sup>	6mm <sup>2</sup>	40A	30mA less than 0.1 sec	
32~40A	3×10mm <sup>2</sup>	10mm <sup>2</sup>	63A	30mA less than 0.1 sec	
40~63A	3×16mm <sup>2</sup>	16mm <sup>2</sup>	80A	30mA less than 0.1 sec	
63~75A	3×25mm <sup>2</sup>	25mm <sup>2</sup>	100A	30mA less than 0.1 sec	
75~101A	3×25mm <sup>2</sup>	25mm <sup>2</sup>	125A	30mA less than 0.1 sec	
101~123A	3×35mm <sup>2</sup>	35mm <sup>2</sup>	160A	30mA less than 0.1 sec	
123~148A	3×50mm <sup>2</sup>	50mm <sup>2</sup>	225A	30mA less than 0.1 sec	
148~186A	3×70mm <sup>2</sup>	70mm <sup>2</sup>	250A	30mA less than 0.1 sec	
186~224A	3×95mm <sup>2</sup>	95mm <sup>2</sup>	280A	30mA less than 0.1 sec	

When the unit will be installed at outdoor, please use the cable which can against UV.

## 6.APPENDIX

---

### 6.2 Comparison table of refrigerant saturation temperature

Pressure (MPa )	0	0.3	0.5	0.8	1	1.3	1.5	1.8	2	2.3
Temperature (R410A)(°C)	-51.3	-20	-9	4	11	19	24	31	35	39
Temperature (R32)(°C)	-52.5	-20	-9	3.5	10	18	23	29.5	33.3	38.7
Pressure (MPa )	2.5	2.8	3	3.3	3.5	3.8	4	4.5	5	5.5
Temperature (R410A)(°C)	43	47	51	55	57	61	64	70	74	80
Temperature (R32)(°C)	42	46.5	49.5	53.5	56	60	62	67.5	72.5	77.4



Code: 20191022-0004